

*Your 1961*  
**CESSNA**

**172B**

AND

*SKY HAWK*

**OWNER'S  
MANUAL**

# PERFORMANCE and SPECIFICATIONS

MODEL SKYHAWK 172 FLOAT PLANE

GROSS WEIGHT . . . . .	2200 lbs	2200 lbs	2220 lbs
SPEED:			
Maximum at Sea Level . . . . .	140 mph	140 mph	104 mph
Maximum Recommended Cruise . . . . .	131 mph	131 mph	101 mph
70% Power at 8000 ft			
RANGE:			
Maximum Recommended Cruise . . . . .	570 mi	570 mi	440 mi
70% Power at 8000 ft	4.4 hr	4.4 hr	4.4 hr
39 Gallons, No Reserve	130 mph	130 mph	101 mph
Maximum Range at 10,000 ft . . . . .	790 mi	790 mi	550 mi
39 Gallons, No Reserve	7.9 hr	7.9 hr	6.0 hr
RATE OF CLIMB AT SEA LEVEL . . . . .	100 mph	100 mph	60 mph
SERVICE CEILING . . . . .	730 fpm	730 fpm	550 fpm
TAKE-OFF:			
Ground Run . . . . .	780 ft	780 ft	1020 ft
Total Distance Over 50-foot Obstacle . . . . .	1370 ft	1370 ft	2100 ft
LANDING:			
Landing Roll . . . . .	680 ft	680 ft	900 ft
Total Distance Over 50-foot Obstacle . . . . .	1115 ft	1115 ft	1345 ft
EMPTY WEIGHT (APPROX) . . . . .	1255 lbs	1325 lbs	1410 lbs
BAGGAGE . . . . .	120 lbs	120 lbs	140 lbs
WING LOADING: Pounds/sq-ft . . . . .	12.6 lbs	12.6 lbs	14.6 lbs
POWER LOADING: Pounds/HP . . . . .	15.2 lbs	15.2 lbs	16.3 lbs
FUEL CAPACITY: Total . . . . .	42 gals.	42 gals.	48 gals.
OIL CAPACITY: Total . . . . .	8 qts	8 qts	8 qts
POWER:			
Continental Engine . . . . .	O-300-C	O-300-D	
145 rated HP at 2700 RPM			
O-300-C . . . . .	Equipped with mechanically engaged starter.		
O-300-D . . . . .	Equipped with an all electric push-button starter; vacuum pump provision on rear of accessory case.		

D880-13  
(RGI-100-4/02)

Copyright © 1981  
Cessna Aircraft Company  
Wichita, Kansas USA

## Congratulations . . . . .

Welcome to the ranks of Cessna owners! Your Cessna has been designed and constructed to give you the most in performance, economy, and comfort. You will find flying it, either for business or pleasure, a pleasant and profitable experience.

This Owner's Manual has been prepared as a guide to help you get the most pleasure and utility from your airplane. It contains information about your Cessna's equipment, operating procedures, and performance; and suggestions for its servicing and care. We urge you to read it from cover to cover, and to refer to it frequently.

Our interest in your flying pleasure has not ceased with your purchase of a Cessna. World-wide, the Cessna Dealer Organization backed by the Cessna Service Department stands ready to serve you. The following services for your Model 172 are offered only by your Cessna Dealer:

**FACTORY TRAINED MECHANICS** to provide you with courteous expert service.

**FACTORY APPROVED SERVICE EQUIPMENT** to provide you with the most efficient and accurate workmanship possible.

**A STOCK OF GENUINE CESSNA SERVICE PARTS** on hand when you need them.

**THE LATEST AUTHORITY INFORMATION FOR SERVICING CESSNA AIRPLANES**, since Cessna Dealers have all of the Service Manuals and Parts Catalogs, kept current by Service Letters and Service News Letters published by Cessna Aircraft Company.

We urge all Cessna owners to use the Cessna Dealer Organization to the fullest.

A current Cessna Dealer Directory accompanies your new airplane. The Directory is revised frequently, and a current copy can be obtained from your Cessna Dealer. Make your Directory one of your cross-country flight planning aids; a warm welcome awaits you at every Cessna Dealer.

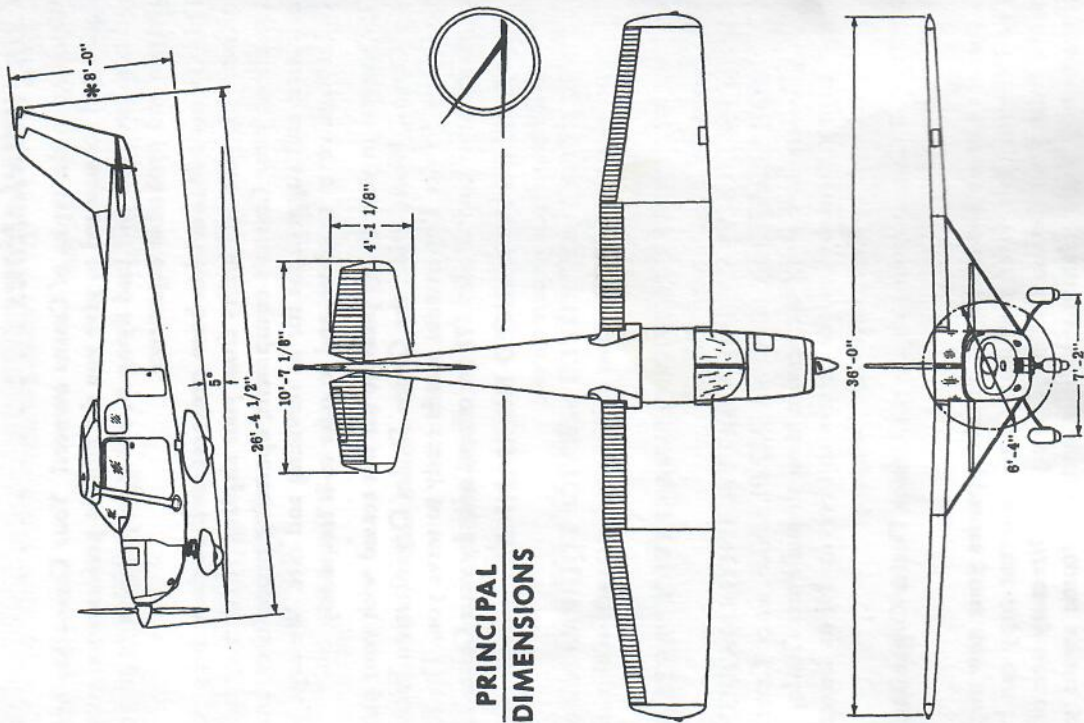

\* Height of fin at maximum gross weight. With airplane empty, height is 8'-7 3/4".  
 If an optional rotating beacon is installed on the fin, add 2 1/2" to both dimensions.

## TABLE OF CONTENTS

	Page
SECTION I — DESCRIPTION .....	1-1
SECTION II — OPERATING CHECK LIST .....	2-1
SECTION III — OPERATING DETAILS .....	3-1
SECTION IV — OPERATING LIMITATIONS .....	4-1
SECTION V — CARE OF THE AIRPLANE .....	5-1
DEALER FOLLOW-UP SYSTEM .....	5-9
SECTION VI — OPERATIONAL DATA .....	6-1
SECTION VII — OPTIONAL SYSTEMS .....	7-1
ALPHABETICAL INDEX .....	Index-1

This manual describes the operation and performance of both the Cessna Model 172 and the Cessna Skyhawk. Equipment described as "Optional" denotes that the subject equipment is optional on the Model 172. Much of this equipment is standard on the Skyhawk model.

# Section 1

description

One of the first steps in obtaining the utmost performance, service, and flying enjoyment from your Cessna is to familiarize yourself with your airplane's equipment, systems, and controls. This section will tell you where each item is located, how it operates, and its functions.

## ENGINE.

The power plant in the Cessna 172 and Skyhawk is a Continental six-cylinder, horizontally-opposed engine. It features a wet-sump oil system, dual magnetos and an up-draft carburetor.

Incorporates a locking lever to prevent inadvertent pulling out of the knob, resulting in leaning or shutting off the fuel supply in the carburetor. To lean the mixture, depress the locking lever while pulling out on the mixture control knob. This operation can be accomplished with one hand, using the thumb to depress the locking lever and two fingers to pull out the control. The locking lever is intended only to prevent inadvertent leaning; the control knob may be pushed in, for rich mixture, without depressing the lever.

## ENGINE CONTROLS.

### THROTTLE.

The throttle (figure 1-2) is the largest of the engine controls and is a push-pull type control. Engine speed is increased by pushing the throttle in or decreased by pulling it out.

### NOTE

To prevent creeping, tighten the knurled friction-type locknut on the control. Turning the nut clockwise increases friction on the throttle; turning it counterclockwise decreases friction.

### MIXTURE CONTROL KNOB.

The mixture control (figure 1-2)

The mixture control is normally set at "full-rich" (all the way in) for starting, take-off, and climb. Maximum performance take-offs from high elevation fields may be made with the mixture leaned out for maximum engine RPM. However a full rich mixture is preferred for better engine cooling.

### CARBURETOR AIR HEAT KNOB.

The carburetor air heat knob (figure 1-2) is a push-pull control which operates the carburetor air intake butterfly to proportion the hot and cold air entering the carburetor.

- Figure 1-1. Instrument Panel
1. Instrument Lights Rheostat
  2. Flight Instrument Group
  3. Compass Correction Card
  4. Optional Radio
  5. Magnetic Compass
  6. Upper Switch and Control Panel (figure 1-3)
  7. Optional Radio Space
  8. Optional Radio Space
  9. Fuel and Oil Instruments
  10. Map Compartment
  11. Tachometer
  12. Lower Switch and Control Panel (figure 1-2)
  13. Optional Instrument Space
  14. Starter Handle (Standard 172 only)
  15. Headphone Jack
  16. Starter Button (Skyhawk Only)

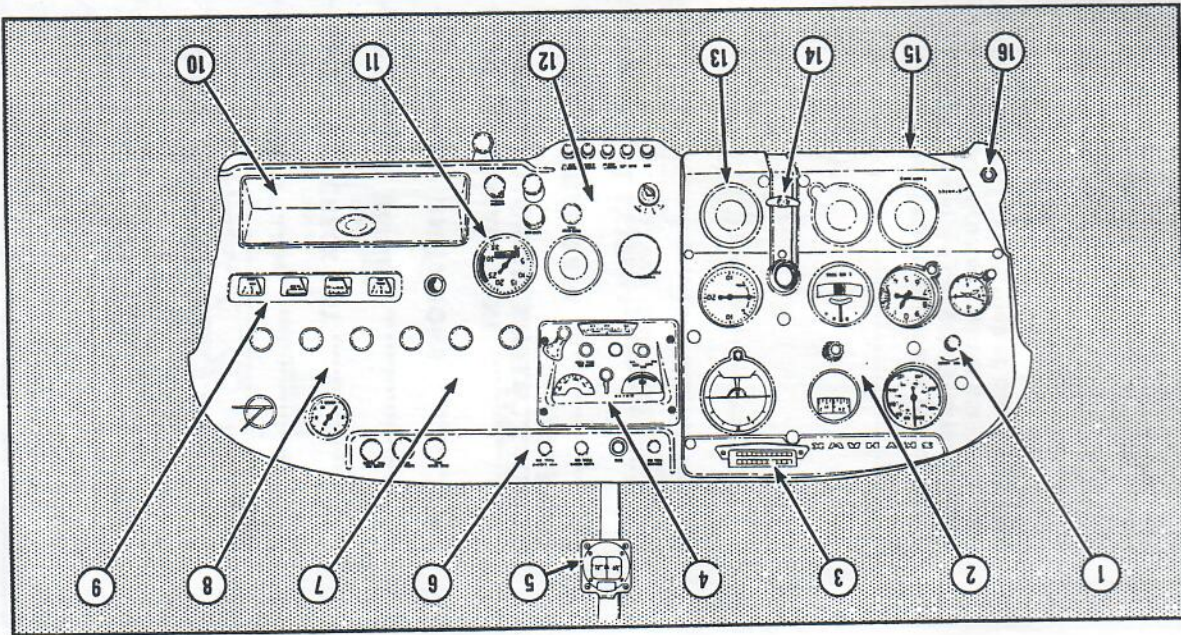

# Section 1 description



One of the first steps in obtaining the utmost performance, service, and flying enjoyment from your Cessna is to familiarize yourself with your airplane's equipment, systems, and controls. This section will tell you where each item is located, how it operates, and its functions.

## ENGINE.

The power plant in the Cessna 172 and Skyhawk is a Continental six-cylinder, horizontally-opposed engine. It features a wet-sump oil system, dual magnetos and an up-draft carburetor.

Incorporates a locking lever to prevent inadvertent pulling out of the knob, resulting in leaning or shutting off the fuel supply in the carburetor. To lean the mixture, depress the locking lever while pulling out on the mixture control knob. This operation can be accomplished with one hand, using the thumb to depress the locking lever and two fingers to pull out the control. The locking lever is intended only to prevent inadvertent leaning; the control knob may be pushed in, for rich mixture, without depressing the lever.

## ENGINE CONTROLS.

### THROTTLE.

The throttle (figure 1-2) is the largest of the engine controls and is a push-pull type control. Engine speed is increased by pushing the throttle in or decreased by pulling it out.

### NOTE

To prevent creeping, tighten the knurled friction-type locknut on the control. Turning the nut clockwise increases friction on the throttle; turning it counterclockwise decreases friction.

### MIXTURE CONTROL KNOB.

The mixture control (figure 1-2)

### CARBURETOR AIR HEAT KNOB.

The carburetor air heat knob (figure 1-2) is a push-pull control which operates the carburetor air intake butterfly to proportion the hot and cold air entering the carburetor.

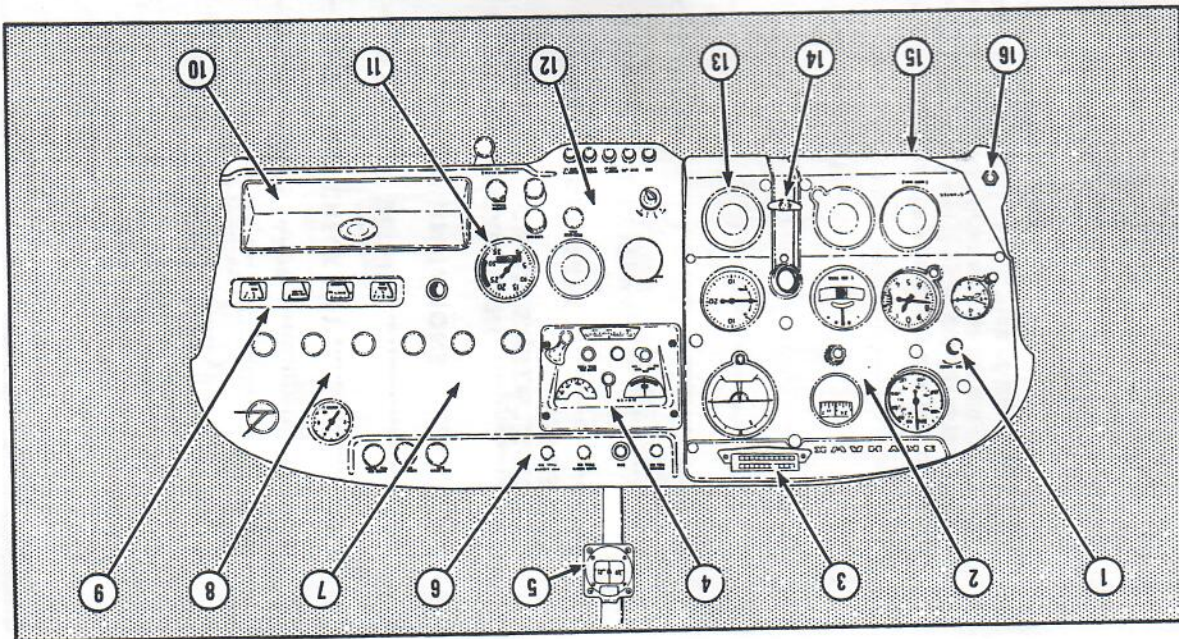

Figure 1-1. Instrument Panel

1. Instrument Lights Rheostat
2. Flight Instrument Group
3. Compass Correction Card
4. Optional Radio
5. Magnetic Compass
6. Upper Switch and Control Panel (figure 1-3)
7. Optional Radio Space
8. Optional Radio Space
9. Fuel and Oil Instruments
10. Map Compartment
11. Tachometer
12. Lower Switch and Control Panel (figure 1-2)
13. Optional Instrument Space
14. Starter Handle (Standard 172 only)
15. Headphone Jack
16. Starter Button (Skyhawk Only)

Pulling the control out raises the temperature of the carburetor air, while pushing it in decreases the temperature. The full-hot position is all the way out and full-cold is all the way in.

Air entering the engine through the heater muff does not pass through the intake filter. Therefore, carburetor heat should not be used when taxiing on dirty, dusty or sandy fields, except briefly to clear the engine immediately before take-off. After a full-stop landing under these conditions, return the heat control to the full cold position so the engine will receive filtered air.

Carburetor ice can form during ground operation with the engine idling. Just after the magneto check prior to take-off, pull the carburetor air heat knob full on to check the function of the carburetor air heater and to remove any ice in the carburetor. After this short check, be sure to push the carburetor air heat knob in to the full cold position. This will give maximum power for the take-off. During climb, watch the engine for any sign of icing (roughness or loss of RPM). If the engine begins to ice, apply full carburetor heat at once.

When full carburetor heat is applied the engine will lose about 275 RPM in cruising flight or 360 RPM at full throttle. In addition to the RPM loss, the engine will run roughly, due to excessively-rich mixture. Therefore, it may be necessary to lean the engine when full carburetor heat is used.

Excessively lean fuel-air mixture will cause overheating and possibly

detonation. Do not lean the mixture unless an increase in engine RPM results.

The correct way to use carburetor heat is to first use full heat to remove any ice that is forming. By trial and error, determine the minimum amount of heat required to prevent the ice from forming; each time removing any ice that is formed by applying full heat. On each subsequent trial, increase the amount of heat applied until no ice forms. On approach glide just before reducing power, apply full carburetor heat and leave in this position. Refer to Cold Weather Operation, Section III, for use of carburetor heat in sub-zero temperatures.

#### IGNITION SWITCH.

The key-operated ignition switch (figure 1-2) controls the dual magneto ignition systems. There are four switch positions designated as follows: "OFF," "R," "L," and "BOTH." The engine should be operated on both magnetos. The "R" and "L" positions are for checking purposes only.

#### ENGINE PRIMER.

The manual plunger-type engine primer delivers an initial charge of raw fuel to the intake manifold, for easier starting. For an initial start in normal air temperatures, use two strokes of the primer. Usually, a hot engine will need no priming.

To operate the primer, proceed as follows:

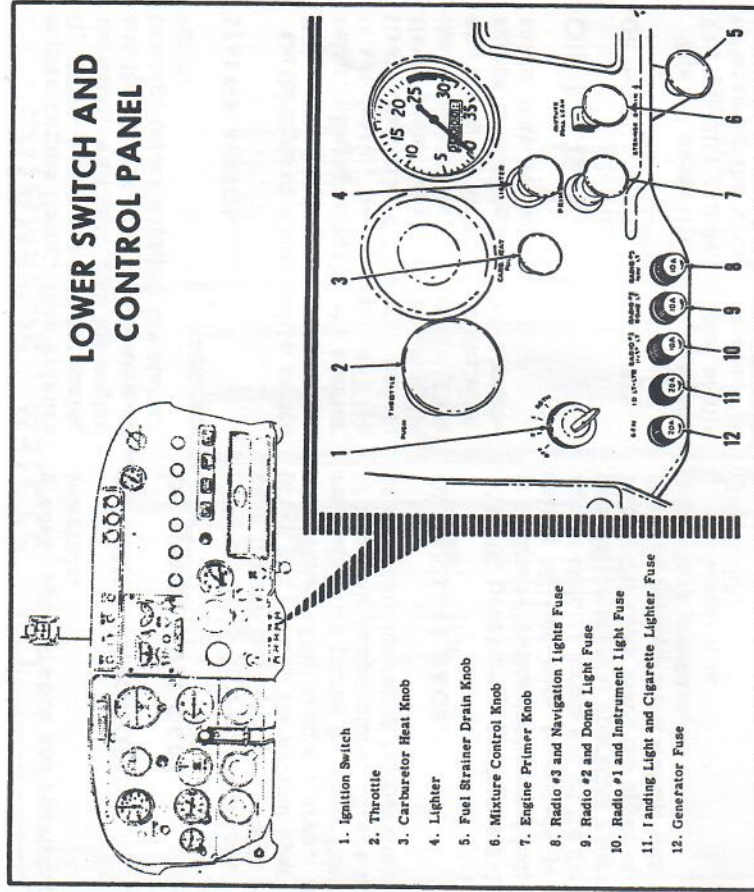

Figure 1-2

(a) First, unlock the plunger by turning the knob until the knob pops part way out.

(b) Slowly pull the plunger all the way out and then push the plunger all the way in. This action is termed "one stroke of the primer."

(c) Normal winter weather will require two to four strokes of the primer, and very cold weather may require ten strokes.

(d) Normally, the engine is started immediately after the priming op-

eration. In very cold weather, it is recommended that the engine be turned over while priming. It may be necessary to continue priming until the engine runs smoothly.

#### STARTER HANDLE.

On the Model 172, a T-shaped starter handle (figure 1-1) engages the starter drive and closes the starter motor switch. To start the engine, pull out the starter handle, hold it until the

engine begins firing, then release it. If the engine stops firing during the start, wait until both the engine and the starter motor have stopped turning, before engaging the starter again.

#### STARTER BUTTON.

On the Skyhawk a push-button switch (figure 1-1) energizes the starter relay. Engagement of the starter is automatic, taking place with the first rotation of the starter motor. Never press the starter button while the propeller is in motion; if the starter drive is engaged while the engine is turning, the drive mechanism may be damaged.

#### OIL SYSTEM.

##### OIL LEVEL.

The oil capacity is eight quarts. The quantity can be checked easily by opening the access door on the left side of the engine cowl and reading the oil level on the dipstick located adjacent to the oil tank cap. In replacing the dipstick, make sure that it is firmly back in place. In replacing the oil filler cap make sure that it is on firmly and turned clockwise as far as it will go to prevent loss of oil through the filler neck. Be sure to close the access door after servicing the oil system. While the minimum supply is four quarts, oil should be added if below six quarts and should be full if an extended flight is planned.

Refer to the Servicing Diagram (figure 5-1) for recommended oil

grades, specification and servicing intervals.

##### OIL SYSTEM INDICATORS.

##### OIL TEMPERATURE GAGE.

The capillary-type oil temperature gage (figure 1-1) is marked with a green arc to show the normal operating range of oil temperatures. A red radial line marks the upper limit of allowable temperature. There is no minimum operating temperature.

##### OIL PRESSURE GAGE.

The oil pressure gage (figure 1-1) is a direct-reading instrument indicating oil pressure in pounds per square inch. A green arc on the dial defines the normal operating range. Red radial lines mark the upper operating pressure limit and the minimum idling pressure.

##### OIL FILTER.

An optional oil filtering system is available for the airplane. When this system is installed, one additional quart of oil should be added during oil and filter element changes to maintain the engine's normal oil supply.

Refer to the Servicing Diagram (figure 5-1) for a listing of the replacement filter element and for servicing instructions.

#### AIR INDUCTION SYSTEM.

Air is ducted to the carburetor

## OIL SYSTEM SCHEMATIC

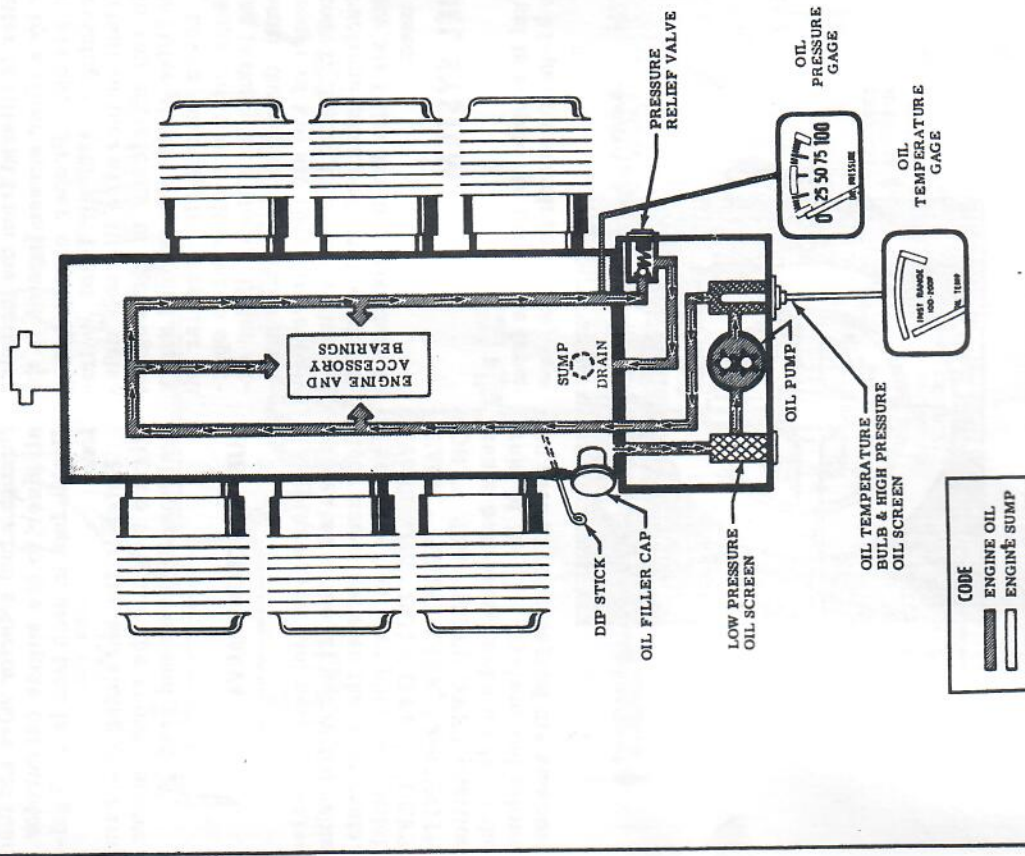

through an air scoop located beneath the engine. Dirt and other foreign matter is filtered from the incoming air by a filter screen located in the air scoop. Proper cleaning and servicing of this air filter is important to increase life and maintain top efficiency of the engine. The filter should be serviced every 25 hours (during the regular oil change) or more often when operating in dusty conditions. Under extremely dusty conditions, daily maintenance of the air filter is recommended. Refer to the servicing instructions stamped on the carburetor air filter for the procedure to be used.

## FUEL SYSTEM.

Fuel is supplied to the engine from two 21-gallon aluminum tanks, one

located in each wing. From these tanks fuel flows by means of gravity through a fuel selector valve and fuel strainer to the engine carburetor. Usable fuel in each tank is 19.5 gallons.

Refer to the Servicing Diagram (figure 5-1) for the recommended fuel specification and grade.

### FUEL SELECTOR VALVE.

A rotary type fuel selector valve is located at the aft end of the cabin floor tunnel between the front seats. The valve has four positions which are labeled "BOTH OFF," "LEFT TANK," "RIGHT TANK," and "BOTH ON." The "BOTH OFF" position seals both wing tanks off from the rest of the fuel system and allows no fuel to pass beyond the selector

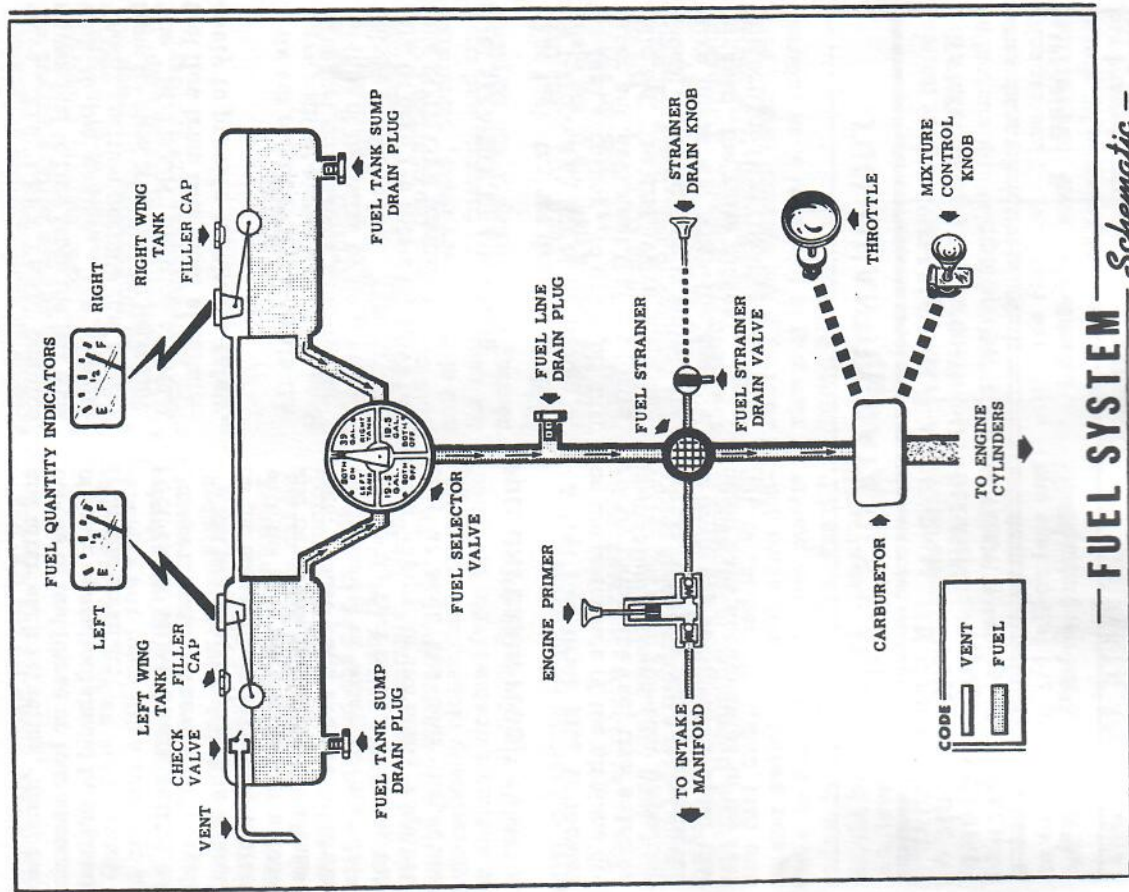
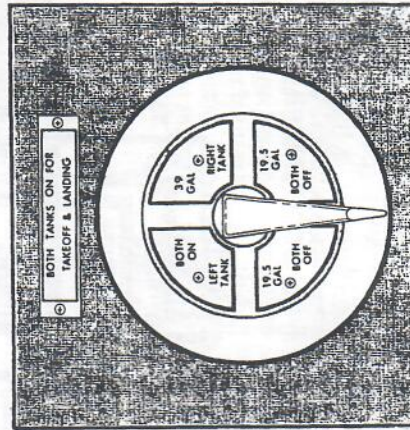

— FUEL SYSTEM Schematic =



ered by an engine-driven generator. A 12-volt storage battery serves as a stand-by power source, supplying current to the system when the generator is inoperative, or when the generator voltage is insufficient to close the reverse-current relay.

#### MASTER SWITCH.

All electrical circuits in the airplane except the engine ignition system are controlled by the master switch (figure 1-3). Pulling out on the switch knob closes the generator field circuit and the operating circuit of the battery relay, permitting the generator to function and connecting the battery to the airplane bus.

If a short circuit or other malfunction should develop in the electrical system, the master switch may be turned OFF. The engine will continue to run, since the magnets are completely separate from the electrical system. The master switch should be turned OFF during starting if the optional ground service plug is connected to an external power source.

#### FUSES.

Fuses (figure 1-2) protect the majority of electrical circuits in the airplane. The circuits controlled by each fuse are indicated above each fuse retainer. Fuse capacity is indicated on each fuse retainer cap. Fuses are removed by pressing the fuse retainers inward and rotating them counterclockwise until they disengage. The faulty fuse may

#### FUEL TANK SUMP DRAIN VALVES.

Quick drain valves are available as optional equipment and replace the conventional wing tank sump drain plugs. The valves facilitate frequent draining of the tank sumps when checking for possible water and sediment. A quick drain fuel sampler cup is provided when these valves are installed. A rigid pin mounted in the center of the cup is used to open the drain valves; the cup then catches the fuel sample. When the cup is withdrawn, the drain valve automatically closes, and any water or sediment drained from the tanks is readily visible in the cup.

#### FUEL QUANTITY INDICATORS.

Two electrically-operated magnetic type fuel quantity indicators (figure 1-1) are provided, each working in conjunction with an electric fuel level transmitter in its respective fuel tank. Turned on by the master switch, the indicators continue to function until the master switch is turned off. Fuel quantity should be checked with the aircraft in a level attitude for accurate indications.

A red arc extends from the empty to 1/4 full range on each indicator dial. When the indicator needle is in this arc, the pilot is warned that the fuel tank is 1/4 full or less and that take-off is not recommended.

#### ELECTRICAL SYSTEM.

Electrical power is supplied by a 12-volt, direct-current system pow-

and after each refueling, about two ounces of fuel (three or four seconds of drain operation) should be drained from the strainer.

#### FUEL TANK SUMP DRAIN PLUGS.

A fuel tank sump drain plug is located on the underside of each wing in line with the rear edge of the cabin door and out a few inches from the fuselage. These plugs are used to drain any sediment or water that may collect in the fuel tanks. Draining the tank sumps is normally required only at each 100-hour inspection period.

#### FUEL LINE DRAIN PLUG.

A fuel line drain plug is located on the underside of the airplane directly below the fuel tank selector valve. At each 100-hour inspection period, this plug should be removed to drain any sediment or water that might have accumulated in the fuel line.

valve. The "LEFT TANK" position allows fuel to flow from the left wing tank to the engine. The "RIGHT TANK" position permits fuel to flow from the right wing tank to the engine. The "BOTH ON" position provides fuel flow from both tanks simultaneously to provide maximum safety.

#### NOTE

The fuel valve handle indicates the setting of the valve by its position above the valve dial. (The drawing on page 1-6 shows the valve in the BOTH OFF position.)

#### FUEL STRAINER DRAIN KNOB.

The fuel strainer drain knob (figure 1-2) opens a valve on the bottom of the fuel strainer, to drain off any water and sediment that may have collected. The drain valve is spring-loaded; when the knob is pulled, the valve opens and when the knob is released, the valve closes. Before the first flight of each day,

#### FUEL QUANTITY DATA (U.S. GALLONS)

TANKS	NO.	USABLE FUEL ALL FLIGHT CONDITIONS	ADDITIONAL USABLE FUEL (LEVEL FLIGHT)	UNUSABLE FUEL (LEVEL FLIGHT)	TOTAL FUEL VOLUME EACH
LEFT WING	1	19.5 gal.	1.0 gal.	0.5 gal.	21.0 gal.
RIGHT WING	1	19.5 gal.	1.0 gal.	0.5 gal.	21.0 gal.

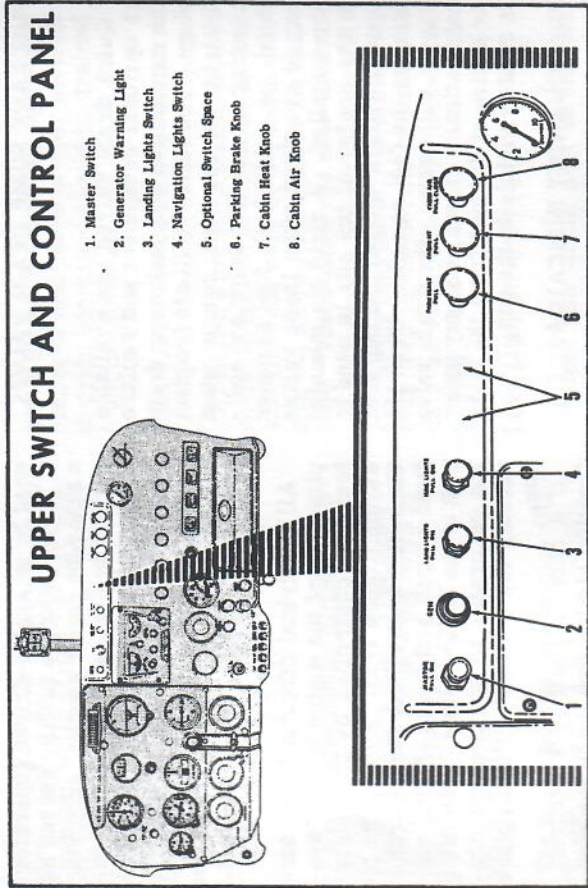

Figure 1-3

then be lifted out and replaced. Spare fuses are held in a clip on the inside of the map compartment door.

The stall warning and optional turn-and-bank indicator circuits are protected by an automatically resetting circuit breaker which provides intermittent emergency operation of these devices in case of a faulty circuit. The optional rotating beacon system and optional pitot and stall warning heater systems are protected by separate circuit breaker switches. The optional clock is protected by a separate fuse mounted near the battery solenoid.

#### GROUND SERVICE RECEPTACLE.

A ground service receptacle (on the

## ELECTRICAL Power Distribution Diagram

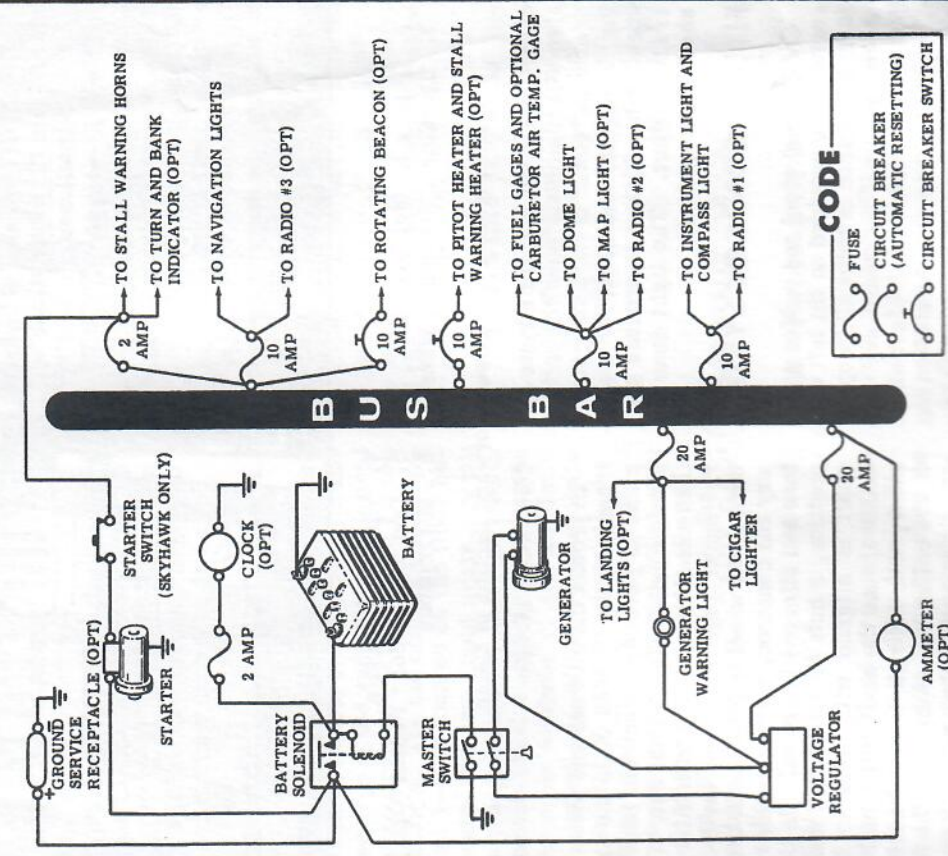

firewall) is available as optional equipment, and may be used for equipment checks and cold-weather starting. The auxiliary power unit must be negative-ground, to agree with the airplane system polarity. With auxiliary power connected, the bus is energized whether the master switch is on or off. When the auxiliary power unit is to be used, the master switch should be left off until the plug has been pulled.

#### GENERATOR WARNING LIGHT.

The red generator warning light (figure 1-3) indicates generator output. The light remains off as long as the generator functions properly. If a malfunction interrupts generator

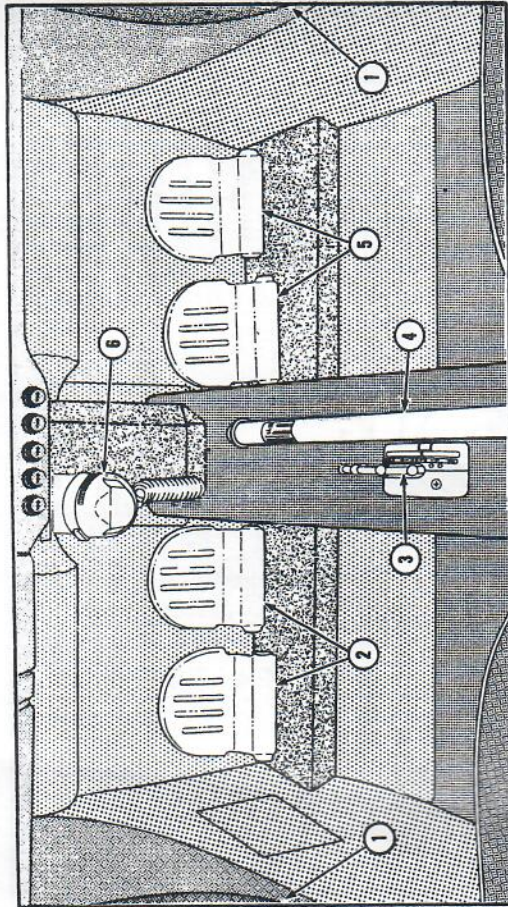

1. Map Pocket
2. Pilot's Rudder Pedals
3. Elevator Tab Control Wheel
4. Wing Flap Handle
5. Copilot's Rudder Pedals (Opt.)
6. Microphone

Figure 1-4. Lower Forward Section of Cabin

#### CONTROLS LOCK.

output, the light will illuminate. It also will illuminate when the battery or external power is on, before starting the engine, and whenever engine speed is insufficient to produce generator output. The light does not show battery drain.

#### FLIGHT CONTROL SYSTEM.

Conventional wheel and rudder pedal controls are provided on the left side (dual installation is optional) to operate the primary flight control surfaces (ailerons, rudder, and elevators). The elevator trim tab, located on the right elevator, is mechanically operated by the trim control wheel located between the front seats.

flag serves as a reminder that the controls must be unlocked before starting the engine. When not in use, the lock should be kept in the glove compartment, where it will be available whenever needed.

#### NOTE

This controls lock is designed for use in moderately-gusty winds up to 30 or 40 MPH. When storm conditions are forecast, additional precautions should be taken.

#### ELEVATOR TAB CONTROL WHEEL.

The elevator trim tab, an auxiliary movable control surface on the trailing edge of the right elevator, is used to neutralize control wheel forces in flight. The tab control wheel (figure 1-4) is located on the floor between the two front seats. A tab position indicator, incorporated in the tab wheel mechanism, indicates the nose attitude of the airplane. Forward and aft movement of the wheel trims nose down and up, respectively. This allows the airplane to be trimmed to fly level with a wide selection of load and speed conditions. Take-off is made with the tab position indicator set in "TAKE-OFF" position.

#### WING FLAP HANDLE.

The wing flaps are operated by moving the wing flap handle (figure 1-4) on the floor between the two front seats. The handle is operated by depressing the thumb button and moving the handle to the de-

sired flap setting. By releasing the thumb button, the handle can be locked to provide 0, 10, 20, 30, and 40-degree flap positions.

The flaps may be lowered or raised during normal flying whenever the airspeed is less than 100 MPH. The flaps supply added lift and considerable drag; the resulting action steepens the glide angle of the airplane enabling the pilot to bring the airplane in over an obstruction and land shorter than could be done without flaps. The use of flaps is not recommended for crosswind take-offs.

For unusually short field take-offs apply 10° flaps (first notch) prior to take-off. An alternate procedure of applying 10° flaps just before the airplane is ready to break ground may be used. For further discussion of the use of wing flaps for take-off, see page 3-4.

#### WING FLAP SETTINGS

For Normal Take-off Up (0°)  
 For Shortest Take-off 1st notch (10°)  
 For Landing  
     2nd notch (20°)  
     3rd notch (30°)  
     4th notch (40°)

#### LANDING GEAR.

##### MAIN LANDING GEAR.

Your airplane is equipped with Cessna's "Land-O-Matic" landing gear. It consists of a tapered, spring steel leaf supporting each main wheel. Simple and strong, this landing gear requires a minimum of maintenance.

### SPEED FAIRINGS.

Speed fairings are available as optional equipment for your airplane. The design purpose of speed fairings is to increase the speed of the aircraft and add to its beauty.

To obtain the maximum speed increase, it was necessary to keep the clearance between the tire and speed fairing to a minimum. An accumulation of mud, snow or ice in the wheel opening will have a braking effect on the wheel. If these elements cannot be avoided, make an inspection of the wheel fairings before each flight and remove any accumulations which may be forming. Refer to Section V for step-by-step speed fairing removal procedure.

### NOSE GEAR.

A steerable nose gear, incorporating an air and oil shock strut, is mounted on the firewall. Nosewheel steering is accomplished through normal operation of the rudder pedals. The nosewheel is steerable through an arc of approximately 10° each side of neutral, after which it becomes free-swiveling up to a maximum deflection of 30° to either side of center. By using the brakes, the airplane can be pivoted about the outer wing strut fitting. The nosewheel is automatically located in the centered position while the aircraft is in the air. Movement of the rudder pedals will not affect the nosewheel while the airplane is in flight. Refer to Section V for shock strut servicing instructions.

### BRAKE SYSTEM.

The hydraulic brakes on the main wheels are conventionally operated by applying toe pressure to either the pilot's or copilot's rudder pedals. The brakes may also be set by operating the parking brake knob.

For parking brake operation, refer to figure 1-5.

### INSTRUMENTS.

All instruments are mounted on the instrument panel except the optional free air temperature gage and the magnetic compass. The free air temperature gage is located in the right cabin ventilator and the compass on the windshield centerstrip. For correct free air temperature readings, the ventilator must be open slightly.

### TURN-AND-BANK INDICATOR.

The optional turn-and-bank indicator is electrically-operated. It has no separate control switch; turned on by the master switch, it operates until the master switch is turned off.

### VACUUM-OPERATED INSTRUMENTS.

Optional instruments operated by the vacuum system include the directional gyro and gyro horizon. A suction gage is also included with the vacuum system to indicate the amount of suction available at all of the instruments.

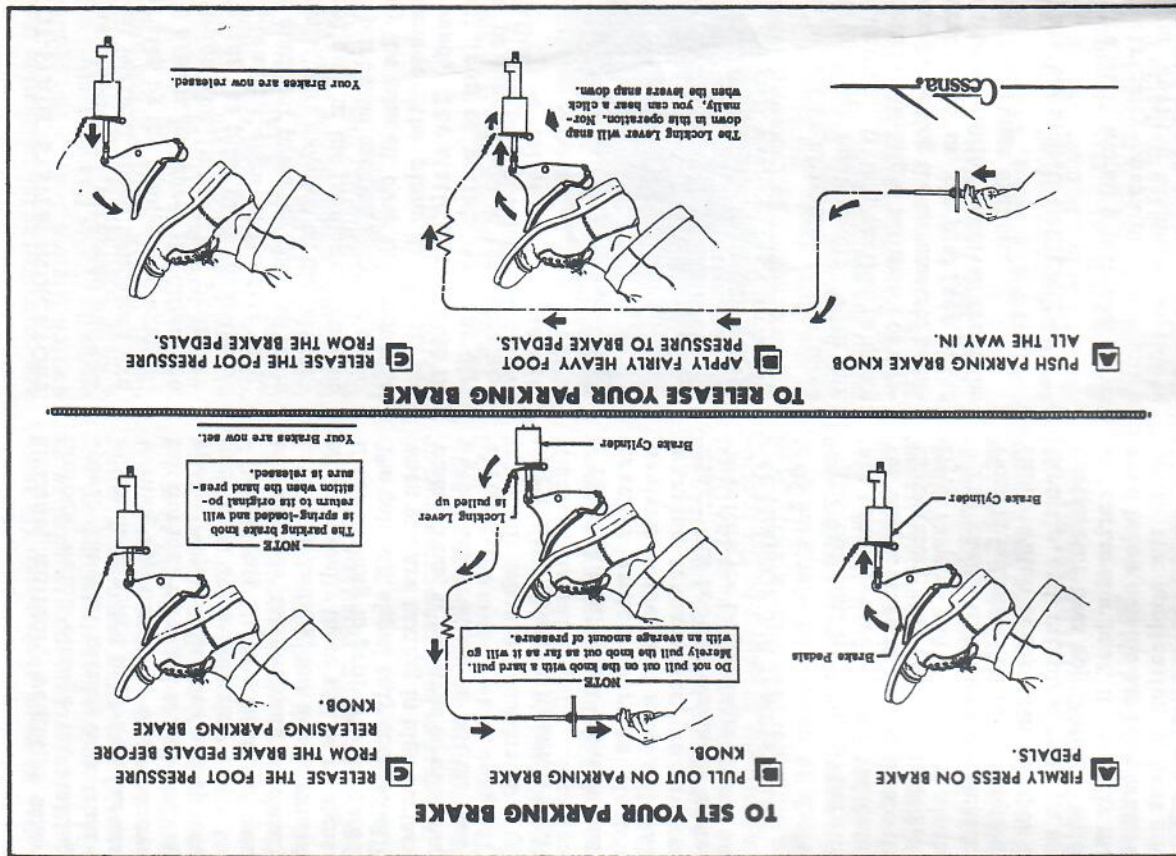

Figure 1-5. Parking Brake Operation

**PITOT-STATIC SYSTEM INDICATORS.**

The altimeter, airspeed and optional vertical speed indicators are operated by the pitot-static system. This system measures the difference between the impact air pressure entering the pitot tube, mounted on the leading edge of the left wing, and static air pressure obtained from a static port mounted on the left forward side of the fuselage. To keep the pitot tube opening clean, a cover may be placed over the pitot tube whenever the plane is idle on the ground. The static port should be kept free of polish, wax, or dirt for proper airspeed indicator operation.



A sensitive altimeter is available as optional equipment. With this altimeter, it is possible to make accurate in-flight altitude corrections by setting the barometric pressure scale on the dial face to the altimeter setting received from the tower or range station.

**STALL WARNING INDICATOR.**

The stall warning indicator is an electrically-operated horn which gives warning whenever a stall is approached, regardless of speed,

altitude, altitude, weight or other factors which change the stalling speed. The stall warning horn transmitter is adjusted to give an audible warning approximately 5 MPH above the normal straight ahead stalling speed. Other attitudes and speeds provide a wider margin.

Under safe flight conditions, you should hear the warning horn only briefly on landing; and due to ground effect, usually there will be no signal if the landing is properly executed. The unit will signal only occasionally when you are taxiing in high surface winds. Thus, it requires no silencing switch which might be left off inadvertently.

**PITOT AND STALL WARNING HEAT.**

The optional pitot heat circuit breaker switch operates electric heaters in the pitot mast and stall warning transmitter, to prevent icing. The heaters should be turned on before ice is encountered.

**CARBURETOR AIR TEMPERATURE GAGE.**

The optional Richter carburetor air temperature system indicates the temperature of the air inside the carburetor, near the throttle butterfly.

The gage will reflect the fluctuations in internal carburetor temperatures which occur with changes in throttle and mixture settings and carburetor heat application. Without carburetor heat, it normally will read below outside air temperature, while the application of heat may bring it considerably above OAT.

The Richter carburetor air temperature system may be used as an aid in applying carburetor heat accurately, avoiding unnecessary power losses due to higher induction air temperatures and loss of ram air pressure. Also, after you have gained experience with it under various weather conditions, you may find it helpful in recognizing potential carburetor icing conditions.

**CYLINDER HEAD TEMPERATURE GAGE.**

A cylinder head temperature gage is available as optional equipment. The gage is self powered, operated by a thermocouple under the lower spark plug on the left rear engine cylinder. This cylinder normally operates at the highest temperature.

**CLOCK.**

An electric clock may be installed as optional equipment in the flight instrument grouping on the instrument panel (see figure 1-1). The clock is connected electrically to the power lead from the battery and is in operation at all times. Because of the low power requirements of the clock, the electrical power drain on the battery is negligible, even if the airplane is not used regularly. If the airplane is put in long term storage, remove the battery.

**LIGHTING EQUIPMENT.****NAVIGATION LIGHTS.**

The conventional navigation lights

are controlled by the navigation lights switch (figure 1-3). The optional navigation lights flasher system uses a three-position switch. The middle detent on the switch is the steady position and all the way out is the flashing position. The wing tip lights are equipped with plastic detectors, visible from the pilots seat, when a flasher system is installed. When the optional rotating beacon is on, the flasher should not be used since there is a possibility that the double flash will be confusing.

**LANDING LIGHT.**

The optional landing light consists of two lamps mounted side-by-side in the leading edge of the left wing. One of the lamps is set to give proper illumination of the runway during landing and take-off while the other lamp is set to provide illumination of the ground for taxiing purposes. The landing light switch (figure 1-3) has three positions to turn on either one lamp or both. To turn on only the taxi light, pull the switch out to the first stop. To turn on both landing and taxi lights, pull the switch out to the second stop. To turn the lights off, push the switch all the way in.

**ROTATING BEACON.**

An optional rotating, anti-collision beacon may be mounted on the tip of the vertical fin. In clear weather, its flashing red beam may be seen for several miles in all directions, making it particularly valuable in the high-density traffic around busy air-

ports. It should not be used, however, when flying through clouds or overcast; its moving beam reflected from water droplets or particles in the atmosphere, particularly at night, can produce vertigo and loss of orientation.

The beacon is turned off and on by a push-pull circuit breaker switch on the instrument panel. Pushing on the switch button turns on the beacon; pulling it out turns the beacon off. A short circuit or overload will trip the circuit breaker and force the switch button out.

#### INSTRUMENT LIGHTS.

A red instrument light is mounted on the cabin ceiling to illuminate the instrument panel during night operation. The light, in conjunction with the compass light, is controlled by a rheostat switch (figure 1-1), labeled "INSTR LIGHTS," located slightly below and to the left of the airspeed indicator. Turn the instrument and light rheostat switch clockwise until the desired illumination is obtained. To turn the lights off, turn the switch counterclockwise as far as it will go.

Optional radio dial lights are controlled by the same rheostat switch which controls operation of the instrument and compass lights.

#### MAP LIGHT.

An optional map light, mounted adjacent to the left cabin ventilator, is controlled by a slide switch mounted on the left door post. The light is fully adjustable to shine in any direction, and a lens adjustment



knob integrally-mounted on the light changes the beam from a spot to a flood illumination.

#### DOME LIGHT.

A dome light is mounted in the cabin ceiling and is controlled by a slide switch mounted in the base of the dome light.

### CABIN HEATING AND VENTILATION SYSTEM.

Comfort of the pilot and passengers is assured by a simple, but highly efficient heating and ventilation system (figure 1-6). Only fresh ram outside air is used for heating and ventilation; no air is recirculated.

Components of the system include two manifold type heaters, a cabin air blending valve, carburetor air mixing valve, and four cabin air outlets. Both manifold heaters provide a continuous supply of heated air for use in the cabin, except when carburetor heat is required; then heated air for the cabin is supplied by the right manifold only. Heated air from the left manifold is used

## CABIN HEATING AND VENTILATION WITH OPTIONAL REAR SEAT VENT SYSTEM

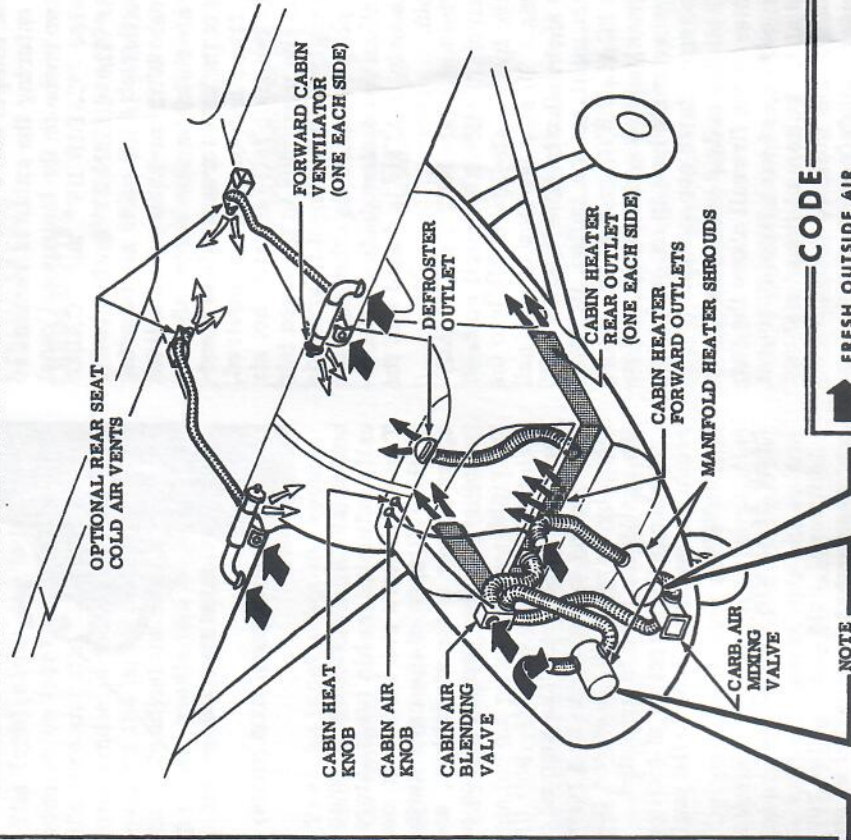

#### CODE

FRESH OUTSIDE AIR  
 VENTILATING AIR FROM FRESH AIR VENTS  
 HEATED FRESH AIR OR VENTILATING AIR DEPENDING ON SETTING OF CABIN HEAT KNOB

#### NOTE

HAVE THE MANIFOLD TYPE CABIN HEATER INSPECTED EVERY 100 HOURS BY YOUR CESSNA DEALER. HE IS QUALIFIED TO KEEP IT IN SAFE, EFFICIENT OPERATING CONDITION.

Figure 1-6

A seat adjustment handle is located behind and at the top of the rear seat back.

## MISCELLANEOUS EQUIPMENT.

### CABIN DOORS.

Two cabin doors are provided on your Cessna 172. Each door incorporates a flush type door handle on the outside and a conventional type

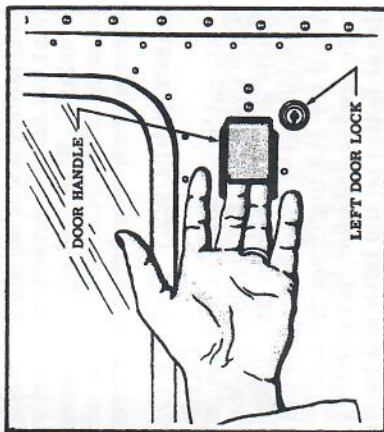

handle on the inside. To open the door from the outside, pull out on the forward edge of the flush type handle. To open the door from the inside, rotate the inside door handle down.

The right cabin door can be locked from the inside only. To lock the door, push up on the thumb latch located on the aft part of the door just below the window. To unlock, push down on the thumb latch.

The left door can be locked from the outside only with a key operated lock. The same key that is used for the ignition is also used to lock the door.

## SEATS.

### FRONT SEATS.

The front seats are individually mounted on tracks and are adjustable fore and aft. The seat adjustment handle is located within easy reach on the left front side of each seat. To adjust the seat, simply pull up on the handle and slide the seat to the most comfortable position.

#### NOTE

Test the front seats for secure latching after adjusting them to the desired position.

### RECLINING FRONT SEATS.

To make long flights more comfortable for the pilot and front seat passenger, optional reclining front seats are available. The seat backs of these seats may be rotated through three positions by pulling up on the handle located on the right side of the seat and leaning back or forward.

Optional headrests are available with the reclining seats installation and are easily installed by inserting the headrest support rods into sockets in the top of the seat back.

### REAR SEAT.

The rear seat has provisions to accommodate two people. The back of the seat is hinged at the bottom to permit seat adjustment and easy access to the baggage compartment.

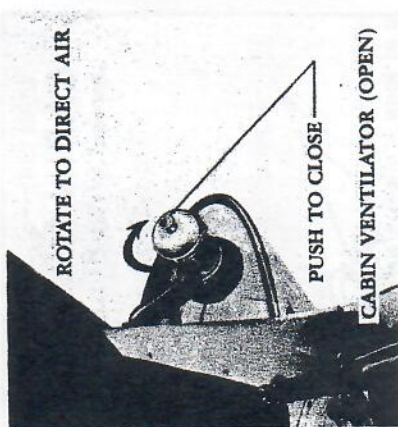

heater ducts, is provided by manually-adjusted cabin ventilators. Two ventilators are installed: one on the left side of the cabin in the upper corner of the windshield, and the other in the same position on the right.

To provide a flow of air, pull the ventilator tube out. The amount of air entering the cabin can be regulated by varying the distance that the ventilator tube is extended.

To change the direction of airflow, rotate the ventilator tube to the position desired.

### REAR SEAT VENTILATORS.

Additional cold air for the rear seat passengers is provided by optional ventilation outlets in the cabin ceiling, above the rear windows. The outlets are ball-and-socket type and may be turned to direct the flow of air as desired. The volume of air from each outlet is regulated by turning a knurled ring on the rim of the outlet.

for carburetor heat when the carburetor air knob on the instrument panel is pulled aft.

The temperature and amount of air entering the cabin is controlled by two knobs on the instrument panel labeled "CABIN HT" and "CABIN AIR." The "CABIN HT" knob actuates a butterfly in the cabin air blending valve. With the knob pulled full aft hot air flows into the cabin. Actuation of the knob forward allows blending from hot to cold as required. With the knob full forward, hot air from the manifolds is bypassed into the engine compartment to preclude the possibility of overheating the manifold and system ducting. Simultaneously, cold air is ducted into the cabin.

The knob labeled "CABIN AIR" controls a sliding firewall shut-off valve to stop all flow of air into the cabin. To stop the flow of air, pull the knob full aft. The "CABIN AIR" knob must not be pulled aft while the "CABIN HT" knob is aft, as the bypass on the blending valve is closed when cabin heat is on, and overheating of ducts can result.

Cabin air outlets are located at the center of the firewall above the rudder pedals, at each front doorpost, and at the bottom of the windshield. None of the outlets, including the windshield defroster outlet, have separate controls which might be inadvertently left shut, preventing the flow of air.

### CABIN VENTILATORS.

Ventilation for the cabin area in addition to that obtained through the

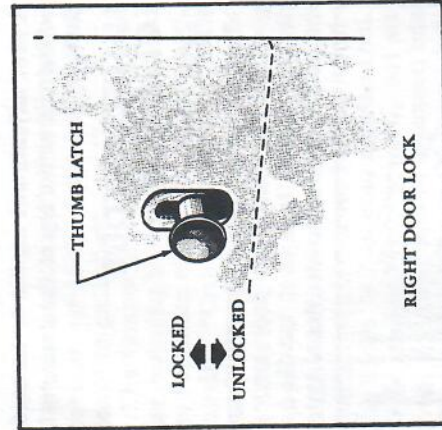

### CABIN WINDOWS.

All cabin windows except the left door window are fixed and permanently sealed. The left door window is hinged at the top and opens outward for additional ventilation.

To open the window, press the release button on the latch and rotate the handle upward. The window will open without pressure, and be held out by spring-loaded limit arms.

### NOTE

In flight, the window should be opened cautiously, since air pressure will push it out with considerable force which may damage the limit arms. Grasp the handle firmly and ease the window out to its open limit.

### BAGGAGE COMPARTMENT.

The baggage compartment, back of the rear seat, may be loaded and un-

loaded through a door on the left side of the fuselage. The door is fitted with a flush-type handle and a lock operated by the ignition key.

The baggage compartment may be reached from inside the cabin by pulling gently forward and down on the rear seat adjustment handle.

### COAT HANGER HOOK.

For your convenience, a coat hanger hook has been installed in the cabin ceiling above the back of the rear seat. Your coats can be hung, full-length and wrinkle-free, between the back of the rear seat and the baggage shelf, without interfering with the comfort of the rear seat passengers.

### UTILITY SHELF.

A utility shelf is located just above the baggage compartment. This shelf will prove very handy for storing hats, brief cases, and small articles.

### MAP POCKET.

Maps and frequently used flying aids may be stored in map pockets in the forward side panels, where they are in easy reach of the pilot's and copilot's seats. Bulkier items, magazines, and small articles may be stored in the pockets on the backs of the front seats.

### FIRE EXTINGUISHER.

An optional fire extinguisher may be installed on the inboard side of

the understructure of the pilot's seat. The extinguisher slides with the seat and does not interfere in any way with the operation of the seat. In case of emergency, remove the extinguisher from its bracket by releasing the spring clip and use it in accordance with the instructions on the extinguisher.

### CARGO TIE-DOWN RINGS.

Eight cargo tie-down rings are available as optional equipment. Two of the rings are used in conjunction with slides which attach to the front seat rails and may be positioned at any point on the rails. The remaining six rings screw into nutplates in the cabin floor. These nutplates are standard equipment in all airplanes. There are two nutplates at the aft end of each outboard front seat rail, and two at the front bulkhead and two at the rear bulkhead of the baggage compartment.

### WINTERIZATION KIT.

An optional winterization kit is available for use at temperatures consistently below freezing. The kit consists of a plate which fits over the air outlet at the lower rear of the cowl. This restricts the amount of air which can flow through the cowl thereby raising the operating temperature of the engine.

As directed by a placard on the plate, remove the winterization plate when ground level outside air temperatures exceed 20°F. Refer to Section III for further discussion concerning cold weather operation.

### LOADING YOUR MODEL 172.

The recommended procedure for loading your Model 172 is as follows: First, load the baggage compartment. Next, load the front seats. Finally, load the rear seat.



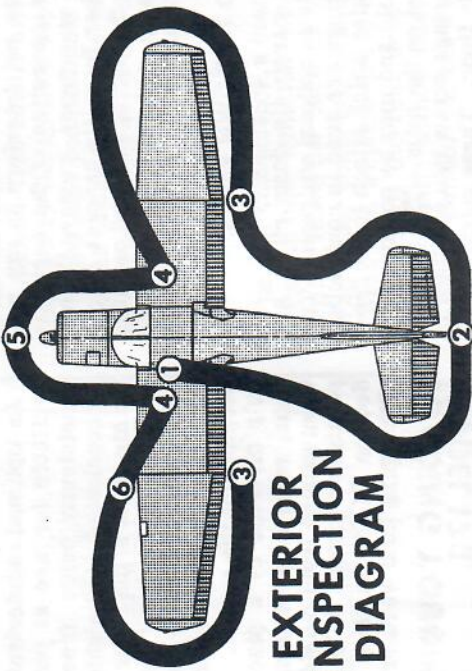

## EXTERIOR INSPECTION DIAGRAM

- 1
  - a. Turn on master switch and check fuel quantity indicators.
  - b. Turn off master switch, check ignition switch for "OFF" position, check fuel tank selector valve handle on "BOTH."
  - c. On first flight of day, pull out strainer drain knob for about four seconds, to clear fuel strainer of possible water and sediment.
  - d. Remove control wheel lock, if installed.
  - e. Check baggage door for security.
- 2
  - a. Remove gust locks, if installed.
  - b. Inspect tail surface hinges and hinge bolts.
  - c. Check trim tabs for proper operation.
  - d. Apply moderate force to each elevator, in opposite directions, checking for looseness at the attachment of the elevators to the torque tube adapter.
  - e. Disconnect tie-down rope or chain.
- 3
  - a. Remove aileron lock, if installed.
  - b. Check aileron and flap hinges.
  - c. Check navigation light for damage.
- 4
  - a. Check main wheel tire for cuts, bruises, and proper inflation.
  - b. Inspect airspeed static source hole on side of fuselage for stoppage (left side only).
  - c. Remove fuel tank cap and check fuel level.
  - d. Disconnect tie-down rope or chain.
  - e. If optional quick drain valves are installed, (on first flight of the day) drain a two-ounce quantity of fuel from wing tank sump to check for presence of water and sediment.
- 5
  - a. Check windshield for cleanliness.
  - b. Check oil level. Do not operate with less than six quarts. Fill for extended flight.
  - c. Inspect cowl access door for security.
  - d. Check propeller nut for security and security.
  - e. Check nosewheel tire for proper inflation.
  - f. Check nosewheel tire for cuts, bruises, and proper inflation.
  - g. Disconnect tie-down rope.
  - h. Make visual check to insure that fuel strainer drain valve is closed after draining operation.
  - i. Check carburetor air filter for restrictions by dust or other foreign matter.
- 6
  - a. Remove pilot tube cover, if installed.
  - b. Inspect pilot tube opening for stoppage.
  - c. Check fuel tank vent opening for stoppage.
  - d. Check stall warning transmitter tab for freedom of operation.

Figure 2-1

# Section 2

## operating check list

This section lists, in Pilot's Check List form, the steps necessary to operate your Cessna 172 efficiently and safely. It is not a check list in its true form as it is considerably longer, but it does cover briefly all of the points that you would want to or should know concerning the information you need for a typical flight.

The flight and operational characteristics of the Cessna 172 are normal in all respects. There are no "unconventional" characteristics or operations that need to be mastered. All controls respond in the normal way within the entire range of operation of the airplane. All airspeeds mentioned in Sections II and III are indicated airspeeds. Corresponding true indicated airspeeds may be obtained from the Airspeed Correction Table in Section VI.

### BEFORE ENTERING THE AIRPLANE.

- (1) Make an exterior inspection in accordance with Figure 2-1.

### BEFORE STARTING THE ENGINE.

- (1) Seats and Seat Belts - Adjust and lock.
- (2) Flight Controls - Check.
- (3) Brakes - Test and set.
- (4) Master Switch - ON.
- (5) Trim Tab - Set.
- (6) Fuel Selector - BOTH ON.

### STARTING ENGINE.

- (1) Carburetor Heat - Cold.
- (2) Mixture - Rich.
- (3) Primer - As required.
- (4) Ignition Switch - BOTH.
- (5) Throttle - Open 1/8" (to idle position).
- (6) Propeller Area - Clear.
- (7) Starter - Engage.

**BEFORE TAKE-OFF.**

- (1) Throttle Setting - 1600 RPM.
- (2) Engine Instruments - Within green arc.
- (3) Magnetos - Check (100 RPM maximum drop).
- (4) Carburetor Heat - Check and ON.
- (5) Flight Controls and Seat Latching - Recheck.
- (6) Wing Flaps - 0° or 10°.
- (7) Trim Tab - TAKE-OFF.
- (8) Cabin Doors - Closed and locked.
- (9) Flight Instruments and Radios - Set.

**TAKE-OFF.****NORMAL TAKE-OFF.**

- (1) Flaps - UP.
- (2) Carburetor Heat - Cold.
- (3) Power - Full throttle.
- (4) Elevator Control - Lift nosewheel at 60 MPH.
- (5) Climb Speed - 80 MPH.

**MAXIMUM PERFORMANCE TAKE-OFF.**

- (1) Flaps - UP.
- (2) Carburetor Heat - Cold.
- (3) Brakes - Apply.
- (4) Power - Full throttle.
- (5) Brakes - Release.
- (6) Elevator Control - Slightly tail low.
- (7) Climb Speed - 60 MPH.

**CLIMB.****NORMAL CLIMB.**

- (1) Airspeed - 80 to 90 MPH.
- (2) Power - Full throttle.
- (3) Mixture - Full rich (unless engine is rough).

**MAXIMUM PERFORMANCE CLIMB.**

- (1) Airspeed - 78 MPH at sea level to 75 MPH at 10,000 ft.
- (2) Power - Full throttle.

- (3) Mixture - Full rich (unless engine is rough).

**CRUISING.**

- (1) Engine Speed - 2100 to 2650 RPM.
- (2) Trim Tab - Adjust.
- (3) Mixture - Lean.

**LET-DOWN.**

- (1) Mixture - Rich.
- (2) Power - As desired.

**BEFORE LANDING.**

- (1) Fuel Selector - BOTH ON.
- (2) Mixture - Rich.
- (3) Airspeed - 70 to 80 MPH (Flaps UP).
- (4) Carburetor Heat - Apply before closing throttle.
- (5) Flaps - As desired (below 100 MPH).
- (6) Airspeed - 65 to 75 MPH (Flaps DOWN).
- (7) Trim Tab - Adjust.

**NORMAL LANDING.**

- (1) Touchdown - Main wheels first.
- (2) Landing Roll - Lower nosewheel gently.
- (3) Braking - Minimum required.

**AFTER LANDING.**

- (1) Flaps - UP.
- (2) Brakes - Set (at parking area).
- (3) Mixture - Full lean.
- (4) Ignition Switch - OFF.
- (5) Master Switch - OFF.

## MODIFIED FUEL MANAGEMENT PROCEDURES

With a combination of highly volatile fuel, high fuel temperature, high operating altitude, and low fuel flow rate in the tank outlet lines, there is a remote possibility of accumulating fuel vapor and encountering power irregularities on some airplanes. To minimize this possibility, the following operating procedures are recommended:

- (1) Take-off and climb to cruise altitude on "both" tanks.  
(This is consistent with current recommendations.)
- (2) When reaching cruise altitude above 5000 feet MSL, promptly switch the fuel selector valve from "both" tanks to either the "right" or "left" tank.
- (3) During cruise, use "left" and "right" tank as required.
- (4) Select "both" tanks for landing as currently recommended.

## POWER RECOVERY TECHNIQUES

In the remote event that vapor is present in sufficient amounts to cause a power irregularity, the following power recovery techniques should be followed:

### OPERATION ON A SINGLE TANK

Should power irregularities occur when operating on a single tank, power can be restored immediately by switching to the opposite tank. In addition, the vapor accumulation in the tank on which the power irregularity occurred will rapidly dissipate itself such that that tank will also be available for normal operation after it has been unused for approximately one (1) minute.

### OPERATION ON BOTH TANKS

Should power irregularities occur with the fuel selector on both tanks, the following steps are to be taken to restore power:

- (1) Switch to a single tank for a period of 60 seconds.
- (2) Then switch to the opposite tank and power will be restored.

# Section 3

## operating details



THE FOLLOWING PARAGRAPHS cover in somewhat greater detail the items entered as a Check List in Section II. Every item in the list is not discussed here. Only those items on the Check List that required further explanation will be found in this section.

### PRE-FLIGHT CHECK.

The exterior inspection described in section II is recommended for the first flight of the day. Inspection procedures for subsequent flights normally are limited to brief checks of the tail surface hinges, fuel and oil quantity, and security of fuel and oil filler caps. If the airplane has been subjected to long-term storage, recent major maintenance, or operation from marginal airports, a more extensive exterior inspection is recommended.

After major maintenance has been performed, the flight and trim tab controls should be double-checked, for free and correct movement.

The security of all inspection plates on the airplane should be checked following periodic inspections. If the airplane has been waxed and polished it is a good practice to check the external static pressure source holes for stoppage.

If the airplane has been exposed to much ground handling in a crowded hangar, it should be checked for dents and scratches on wings, fuselage, and tail surfaces, as well as

damage to navigation and landing lights, and radio antennas. Outside storage for long periods may result in water and obstructions in the airspeed system lines, condensation in fuel tanks, and dust and dirt on the intake air filters and engine cooling fins.

Operation from a gravel or cinder field will require extra attention to propeller tips and abrasion on leading edges of the horizontal tail.

Airplanes that are operated from rough fields, especially at high altitudes are subjected to abnormal landing gear abuse. A frequent check of all components of the landing gear shock strut, tires, and brakes is important.

If night flying is anticipated, all exterior and interior lights should be checked for proper illumination. Cold weather flights involve a careful check of other specific areas that will be discussed in a separate paragraph.

### STARTING ENGINE.

Ordinarily the engine starts easily with one or two strokes of primer

# TAXING DIAGRAM

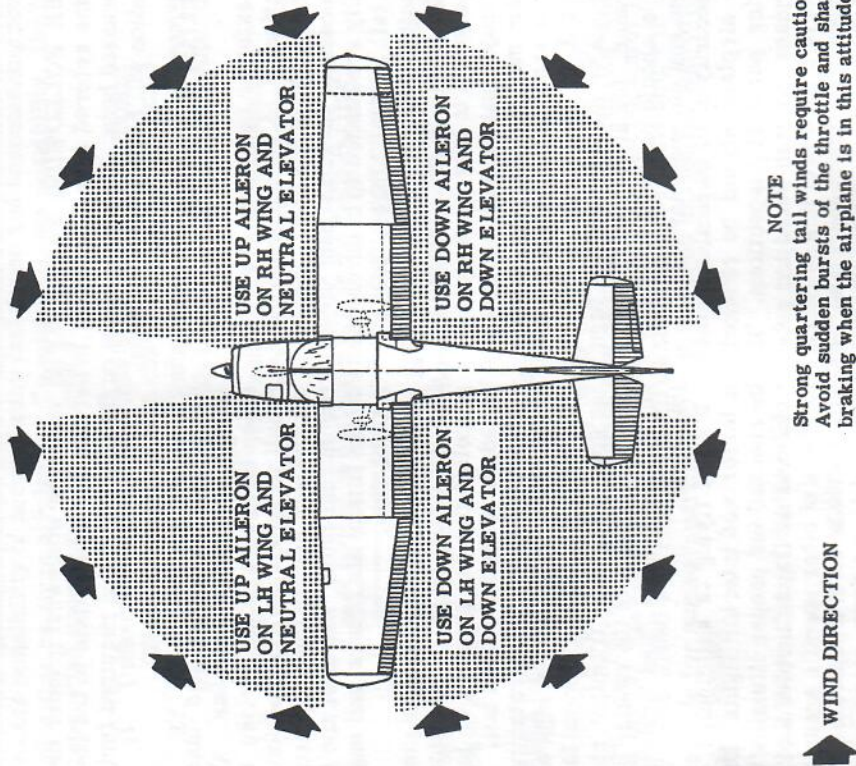

**NOTE**

Strong quartering tail winds require caution. Avoid sudden bursts of the throttle and sharp braking when the airplane is in this attitude. Use the steerable nose wheel and rudder to maintain direction.

In warm temperatures to six strokes in cold weather, with the throttle open approximately 1/8 inch. In extremely cold temperatures, it may be necessary to continue priming while cranking. Weak intermittent explosions followed by puffs of black smoke from the exhaust stack indicates overpriming or flooding. Excess fuel can be cleaned from the combustion chambers by the following procedure: Set the mixture control in full lean position, throttle full open, ignition switch OFF, and crank the engine through several revolutions with the starter. Repeat the starting procedure without any additional priming. If the engine is underprimed (most likely in cold weather with a cold engine) it will not fire at all, and additional priming will be necessary. As soon as the cylinders begin to fire, open the throttle slightly to keep it running. After starting, if the oil gage does not begin to show pressure within 30 seconds in the summertime and weather, stop engine and investigate. Lack of oil pressure can cause serious engine damage. After starting, avoid the use of carburetor heat unless icing conditions prevail.

## TAXING.

Release the parking brake before taxiing and use the minimum amount of power necessary to start the airplane moving. During taxi, and especially when taxiing downwind, the RPM should be held down to prevent excessive taxi speeds. Taxiing should be done at a speed slow enough

to make the use of brakes almost entirely unnecessary. Using the brakes as sparingly as possible will prevent undue wear and strain on the tires, brakes, and landing gear. Normal steering is accomplished by applying pressure to the rudder pedal in the direction the airplane is to be turned. For smaller radius turns, at slow speed, the brakes may be used on the inside wheel. At slow taxi speed, this airplane may be pivoted about the outboard strut fitting without sliding the tires. When taxiing in crosswinds it is important that speed and use of brakes be held to a minimum and that all controls be utilized (see taxiing diagram on page 3-2) to maintain directional control and balance.

**NOTE**

Caution should be used when taxiing over rough fields to avoid excessive loads on the nosewheel. Rough use of brakes and power also add to nosewheel load. A good rule of thumb: "Use minimum speed, power, and brakes."

Taxiing over loose gravel or cinders should be done at low engine speed to avoid abrasion and stone damage to the propeller tips. Full throttle runups over loose gravel are especially harmful to propeller tips. When take-offs must be made over a gravel surface, it is very important that the throttle be advanced slowly. This allows the airplane to start rolling before high RPM is developed, and the gravel will be blown back of the propeller rather than pulled into

ground, make a coordinated turn into the wind to correct for drift.

## CLIMB.

For detailed data, see the Climb Performance Chart in Section VI. Normal climbs are conducted at 80 to 90 MPH with flaps up and full throttle for best engine cooling. The mixture should be full rich unless the engine is rough due to too rich a mixture. The best rate-of-climb speeds range from 78 MPH at sea level to 75 MPH at 10,000 feet. If an obstruction dictates the use of a steep climb angle, the best angle-of-climb speed should be used with flaps up and full throttle. These speeds vary from 56 MPH at sea level to 67 MPH at 10,000 feet.

## NOTE

Steep climbs at these low speeds should be of short duration because of poor engine cooling.

## CRUISE.

Maximum allowable cruising RPM's are 2450 at sea level, 2550 at 5000 feet, and 2650 RPM at 10,000 feet. At standard air temperature these engine speeds provide 73% power at sea level and 71% power at 5000 feet. These RPM's require progressively higher throttle openings as altitude is increased until at 8000 feet, full throttle is reached and results in 70% power.

Cruising can be done most efficiently at high altitudes because of lower air density and therefore lower air-

to a 50-foot obstacle. Therefore the use of 10° flap is reserved for minimum ground runs or for take-off from soft or rough fields with no obstacles ahead.

If 10° of flaps are used in ground run, it is preferable to leave them extended rather than retract them in the climb to the obstacle. The exception to this rule would be in a high altitude take-off in hot weather where climb would be marginal with flaps 10°.

Flap deflections of 30° and 40° are not recommended at any time for take-off. General rules for flap operation during take-off are as follows:

DON'T, under marginal conditions, leave flaps down so long that you are losing both climb and airspeed. DON'T release flaps with airspeed below flaps up stalling speed (See Stalling Speed Table in Section VI). DO slowly release the flaps as soon as you reasonably can after take-off, preferably 50 feet or more over terrain obstacles.

Consult the take-off chart (figure 6-3) for take-off distances under various gross weight, altitude, and headwind conditions.

Take-offs into strong crosswinds normally are performed with the minimum flap setting necessary for the field length, to minimize the drift angle immediately after take-off. The airplane is accelerated to a speed slightly higher than normal, then pulled off abruptly to prevent possible settling back to the runway while drifting. When clear of the

The engine should be checked for smooth idling at approximately 500 RPM, although prolonged idling is done above 600 RPM for better engine lubrication.

If instrument or night flights are contemplated, a careful check should be made of vacuum pump operation. The minimum and maximum suction limits are 3.8 and 4.2 in's. of mercury. The condition of the generator is also important since satisfactory operation of all radio equipment and electrical instruments is essential to instrument flight. The generator is checked by noting that the warning light is out with the engine speed above 1000 RPM.

A simple last-minute recheck of important items should include a glance to see that the mixture and carburetor heat knobs are full in, all flight controls have free and correct movement, and the fuel selector is set to "Both On."

## TAKE-OFF.

Since the use of full throttle is not recommended in the static run-up, it is important to check full-throttle engine operation early in the take-off run. Any signs of rough engine operation or sluggish engine acceleration is good cause for discontinuing the take-off. If this occurs, you are justified in making a thorough full-throttle static run-up before another take-off is attempted.

Normal and obstacle clearance take-offs are performed with flaps up. The use of 10° flaps will shorten the ground run approximately 10%, but this advantage is lost in the climb

it. When unavoidable small dents appear in the propeller blade, they should be immediately corrected as described in section V under propeller care.

## BEFORE TAKE-OFF.

Most of the warm up will have been conducted during taxi, and additional warm up before take-off should be restricted to the checks outlined in Section II. Since the engine is closely cowed for efficient in-flight cooling, precautions should be taken to avoid overheating on the ground. Full throttle checks on the ground are not recommended unless the pilot has good reason to suspect that the engine is not turning up properly. If a full throttle run-up is necessary the engine should run smoothly and turn 2230 to 2330 RPM with carburetor heat off. Engine run-ups should not be performed over loose gravel or cinders because of possible stone damage or abrasion to the propeller tips.

If the ignition system produces an engine speed drop greater than 100 RPM, the warm up should be continued a minute or two longer prior to rechecking the system. If there is doubt concerning the operation of the ignition system, checks at higher engine speed may confirm the deficiency. In general, a drop in excess of 100 RPM with a warm engine at 1600 RPM should be considered excessive. If the engine accelerates smoothly and the oil pressure remains steady at some value between 30 to 60 lbs./sq. in. the engine is warm enough for take-off.

plane drag. This is illustrated in the following table for 70% power at various altitudes.

Altitude	RPM	True Airspeed
Sea Level	2410	121
5000 feet	2530	127
8000 feet	Full Throttle	131

For detailed cruise performance, refer to the Cruise Performance Chart in Section VI. It should be noted that greater range can be obtained at lower power settings. Therefore if a destination is slightly out of reach in one flight at normal cruise speed it may save time and money to make the trip non-stop at a lower speed. Range and endurance figures in Section VI are given for lean mixture from 2500 feet to 12,500 feet and for rich mixture at 2500 feet and 5000 feet. All figures, are based on zero wind, 39 gallons of fuel for cruise, McCauley 1C172/EM7653 propeller, 2200 pounds gross weight and standard atmospheric conditions. At any altitude, the mixture should be leaned by pulling the knob out until maximum RPM is obtained with fixed throttle and then the control is pushed in toward "full rich" until RPM starts to decrease. The mixture should be readjusted for each change in power, altitude, or carburetor heat.

Allowances for fuel reserve, headwinds, take-off and climb, and variations in mixture leaning technique should be made and are in addition to those shown on the charts. Other indeterminate variables such as carburetor metering characteristics,

engine and propeller condition, and turbulence of the atmosphere may account for variations of 10% or more in maximum range.

## STALLS.

The stalling speeds are shown in Section VI for forward c.g., normal category, full gross weight conditions. They are presented as true indicated airspeed because indicated airspeeds are inaccurate near the stall. Other loadings result in slower stalling speeds. The horn stall warning indicator produces a steady signal 5 to 10 MPH before the actual stall is reached and remains on until the airplane flight attitude is changed. Fast landings will not produce a signal.

The stall characteristics are conventional for the flaps up and flaps down condition. Slight elevator buffeting may occur just before the stall with flaps down.

## LANDING.

Normal landings are made power off with any flap setting. Slips are prohibited in full flap approaches because of a downward pitch encountered under certain combinations of airspeed and sideslip angle. Approach glides are normally made at 70 to 80 MPH with flaps up, or 65 to 75 with flaps down, depending upon the turbulence of the air.

Landings are usually made on the main landing wheels to reduce the landing speed and the subsequent need for braking in the landing roll. The nosewheel is lowered gently to the

runway after the speed is diminished to avoid unnecessary nose gear strain. This procedure is especially important in rough field landings.

Excessive braking in the landing roll is not recommended because of the probability of skidding the main wheels with the resulting loss of braking effectiveness and damage to the tires.

For a short field landing, make a power off approach at 60 MPH with flaps 40° (fourth notch) and land on the main wheels first. Immediately after touchdown, lower the nose gear to the ground and apply heavy braking as required. Raising the flaps after landing will provide more efficient braking.

When landing in a strong crosswind, use the minimum flap setting required for the field length. Use a wing low, crab, or a combination method of drift correction and land in a nearly level attitude. Hold a straight course with the steerable nosewheel and occasional braking if necessary.

## COLD WEATHER OPERATION.

Prior to starting on cold mornings, it is advisable to pull the propeller through several times by hand to "break loose" or "limber" the oil, thus conserving battery energy. In extremely cold (-20°F) weather the use of an external pre-heater is recommended whenever possible to reduce wear and abuse to the engine and the electrical system. Cold weather starting procedures are as follows:

- (1) Clear propeller.

- (2) Turn master switch ON.
- (3) With magneto switch OFF and throttle closed, prime the engine four to ten strokes as the engine is being turned over.
- (4) Turn magneto switches ON.
- (5) Open throttle 1/8" (to idle position) and engage starter to start engine.

## NOTE

In extremely cold weather a few strokes of the primer as the engine fires will enable the engine to keep running. (Avoid over-priming.) After priming, push primer all the way in and turn to locked position to avoid possibility of engine drawing fuel through the primer. Do not attempt a second start until engine has come to a complete stop from the first attempt. Failure to do this may result in damage to the starting gear.

During cold weather operations, no indication will be apparent on the oil temperature gage prior to take-off if outside air temperatures are very cold. After a suitable warm-up period (2 to 5 minutes at 1000 RPM), accelerate the engine several times to higher engine RPM. If the engine accelerates smoothly and the oil pressure remains normal and steady, the airplane is ready for take-off.

When operating in sub-zero temperature, avoid using partial carburetor heat. Partial heat may increase the carburetor air temperature to the 32° to 80°F range, where

icing is critical under certain atmospheric conditions.  
For operation at temperatures consistently below freezing, a winterization kit consisting of plates for partially closing cowl openings is available at your Cessna dealer for a nominal charge.



### OPERATIONS AUTHORIZED.

Your Cessna exceeds the requirements of airworthiness as set forth by the United States Government, and is certificated under FAA Type Certificate No. 3A12 as Cessna Model No. 172B.

With standard equipment, the airplane is approved for day and night operations under VFR. Additional optional equipment is available to increase its utility and to make it authorized for use under IFR day and night. An owner of a properly equipped Cessna is eligible to obtain approval for its operation on single-engine scheduled airline service under VFR.

### MANEUVERS - NORMAL CATEGORY.

The Model 172 exceeds the requirements of the Civil Air Regulations, Part 3, set forth by the United States Government for airworthiness. Spins and aerobatic maneuvers are not permitted in normal category airplanes in compliance with these regulations. In connection with the foregoing, the following gross weights and flight load factors apply:

Gross Weight	.....	2200 lbs.
Flight Load Factor *Flaps Up	.....	+3.8 -1.52
Flight Load Factor *Flaps Down	.....	+3.5

\*The design load factors are 150% of the above, and in all cases, the structure meets or exceeds design loads.

Your airplane must be operated in accordance with all FAA approved markings, placards and check lists in the airplane. If there is any information in this section which contradicts the FAA approved markings, placards and check lists, it is to be disregarded.

### MANEUVERS - UTILITY CATEGORY.

This airplane is not designed for purely aerobatic flight. However, in the acquisition of various certificates such as commercial pilot, instrument pilot and flight instructor, certain maneuvers are required by the FAA. All of these maneuvers are permitted in the Cessna 172 when operated in the utility category. In connection with the utility category, the following gross weight and flight load factors apply, with recommended entry speeds for maneuvers as shown.

Maximum Design Weight	1950 lbs.
Flight Maneuvering Load Factor, Flaps Up	+4.4 -1.76
Flight Maneuvering Load Factor, Flaps Down	+3.5

No acrobatic maneuvers are approved except those listed below:

Maneuver	Entry Speed
Chandelles	115 mph (100 knots)
Lazy Eights	115 mph (100 knots)
Steep Turns	115 mph (100 knots)
Spins	Slow Deceleration
Stalls (Except Whip Stalls)	Slow Deceleration

The baggage compartment and rear seat must not be occupied.

Aerobatics that may impose high inverted loads should not be attempted. The important thing to bear in mind in flight maneuvers is that the Cessna 172 is clean in aerodynamic design and will build up speed quickly with the nose down. Proper speed control is an essential requirement for execution of any maneuver and care should always be exercised to avoid excessive speed which in turn can impose excessive loads. In the execution of all maneuvers avoid abrupt use of controls.

### AIRSPEED LIMITATIONS.

The following are the certificated true indicated airspeed limits for the Cessna 172:

Maximum (Glide or dive, smooth air)	160 mph (red line)
Caution Range (Level flight or climb)	140-160 mph (yellow arc)
Normal Range (Level flight or climb)	59-140 mph (green arc)
Flap Operating Range	55-100 mph (white arc)
Maneuvering Speed*	115 mph

\*The maximum speed at which you can use abrupt control travel without exceeding the design load factor.

### ENGINE OPERATION LIMITATIONS.

Power and Speed	145 bhp at 2700 rpm
-----------------	---------------------

### ENGINE INSTRUMENT MARKINGS.

#### OIL TEMPERATURE GAGE.

Normal Operating Range	Green Arc
Maximum Allowable	Red Line

#### OIL PRESSURE GAGE.

Minimum Idling	10 psi (red line)
Normal Operating Range	30-60 psi (green arc)
Maximum	100 psi (red line)

#### FUEL QUANTITY INDICATORS.

Empty (1-1/2 gallons unusable each tank)	E (red line)
*Not recommended for take-off	E to 1/4 (red arc)
*This fuel available for all normal operations.	

#### TACHOMETER

##### Normal Operating Range:

At sea level	2200-2450 (inner green arc)
At 5000 feet	2200-2550 (middle green arc)
At 10,000 feet	2200-2650 (outer green arc)
Maximum Allowable	2700 (red line)

#### CYLINDER HEAD TEMPERATURE GAGE.

Normal Operating Range	350° to 475° F (green arc)
Maximum	525° F (red line)

#### WEIGHT AND BALANCE.

The information presented in this section will enable you to operate your 172B within the prescribed weight and center of gravity limitations. In figuring your loading problems be certain that you use the Licensed Empty Weight of your particular airplane as shown on its Weight and Balance Data sheet. This sheet plus an Equipment List is included with each airplane as it leaves the factory. The FAA requires that any change in the original equipment affecting the empty weight center of gravity be recorded on a Repair and Alteration Form ACA-337.

#### READ BEFORE WORKING LOADING PROBLEM FOR YOUR AIRPLANE.

To figure the weight for your airplane in the same manner as the sample problem on page 4-5, proceed as follows:

Step.1. Take the licensed Empty Weight and Moment/1000 from the Weight and Balance Data sheet carried in your airplane and write them down in two columns in the manner shown in the sample problem.



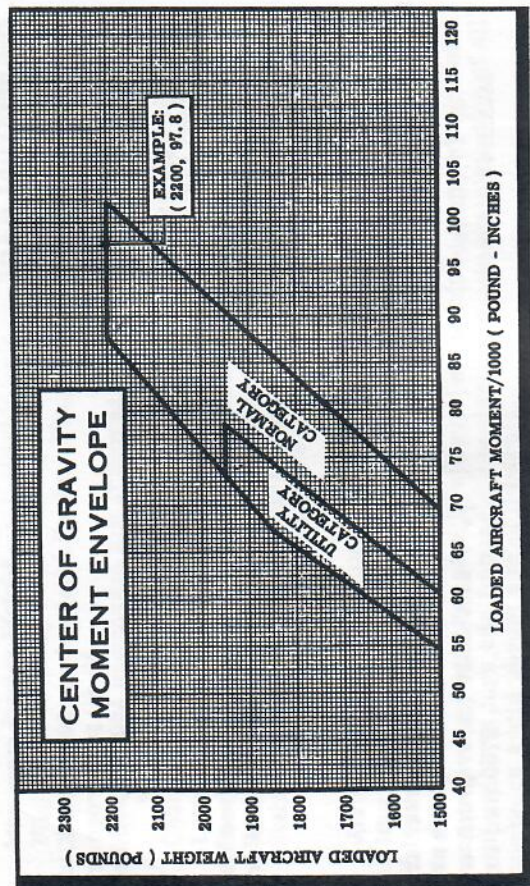

Step 2. Write down the weight and moment/1000 for the oil in the proper columns. Since you usually have full load of oil for a trip, you figure 8 qts. at 15.0 lbs. and a moment of -0.3. You may use these same figures every time and consider this also a non-variable.

Step 3. Add the weight of yourself and the front passenger. Refer to the loading graph (on page 4-4) and find this weight at the left side of the graph and then go across the graph horizontally to the right until you intersect the line identified as "PILOT AND FRONT PASSENGER." After intersecting the line drop down vertically to the bottom line and read the moment/1000 given on the scale. Now write down this weight and moment/1000 for you and the front passenger in the proper columns.

Step 4. Proceed as you did in Step 3, except use the line identified as "FUEL" and 6 lbs. per gallon for the amount of gasoline you are carrying, and read the moment/1000 from the loading graph. Write the weight and moment/1000 in the proper columns.

Step 5. Proceed as you did in Step 3, except use the line identified as "REAR PASSENGERS," and read the moment/1000 for the combined weight of the rear passengers being carried. Write the weight and moment/1000 in the proper columns.

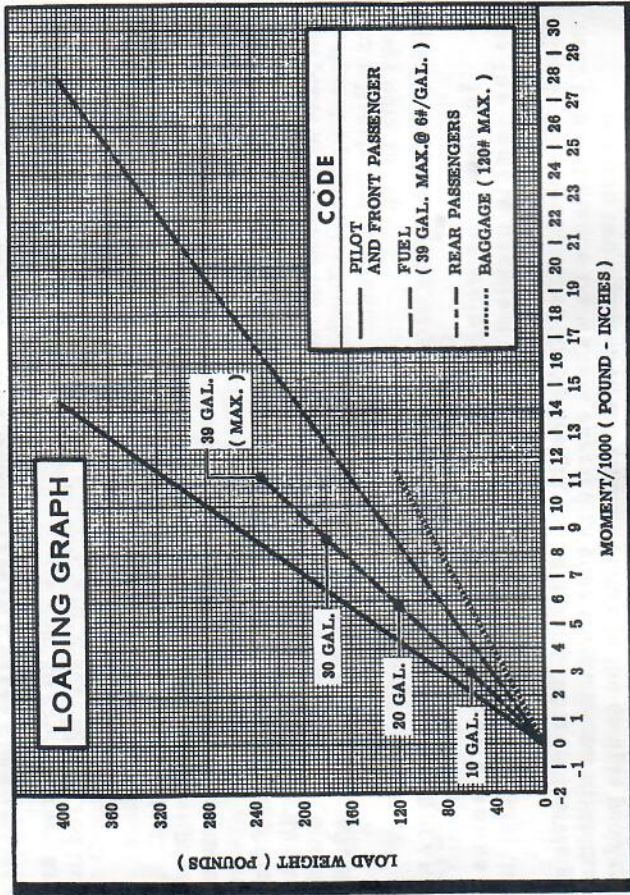

SAMPLE LOADING PROBLEM	Sample Airplane		Your Airplane	
	Weight (lbs)	Moment (lb.-ins. /1000)	Weight	Moment
1. Licensed Empty Weight (Sample Airplane) ...	1305.5	49.5		
2. Oil - 8 Qts.* .....	15.0	-0.3	15.0	-0.3
3. Pilot & Front Passenger .....	340.0	12.2		
4. Fuel. (22.5 Gal at 6#/Gal) .....	135.0	6.5		
5. Rear Passengers .....	340.0	23.8		
6. Baggage .....	64.5	6.1		
7. Total Aircraft Weight (Loaded) .....	2200.0	97.8		

8. Locate this point (2200 at 97.8 on the center of gravity envelope, and since this point falls within the envelope the loading is acceptable.

\*Note: Normally full oil may be assumed for all flights.

Step 6. Proceed as you did in Step 3, except use the line identified as "BAG-GAGE," and read the moment/1000 for the number of pounds of baggage being carried. Write the weight and moment/1000 in the proper columns.

Step 7. Add the weight column. The total must be 2200 lbs., or below, or you must lighten your aircraft load. Add the moment column (remember to subtract rather than add the oil moment because it is a minus quantity).

Step 8. Refer to the Center of Gravity Moment Envelope. Locate the total weight on the scale on the left hand side of the graph and, from this point, follow a line horizontally to the right. Locate the total moment/1000 on the scale running across the bottom of the graph and, from this point, follow a line vertically up until you intersect the line running horizontally from your total weight. If the point, where the two lines intersect is within the envelope, your airplane is loaded within approved limits. If the point of intersection falls outside the envelope, your load must be adjusted before flight.

# Section 5

## Care of the Airplane



If your airplane is to retain that new plane performance, stamina, and dependability, certain inspection and maintenance requirements must be followed. It is always wise to follow a planned schedule of lubrication and maintenance based on the climatic and flying conditions encountered in your locality.

Keep in touch with your Cessna dealer and take advantage of his knowledge and experience. He knows your airplane and how to maintain it. He will remind you when lubrications and oil changes are necessary and about other seasonal and periodic services.

### GROUND HANDLING.

The airplane is most easily and safely maneuvered by hand with a tow-bar attached to the nosewheel. Always use the tow-bar (optional equipment) when one is available. When moving the airplane by hand, if no tow-bar is available, push down at the front edge of the stabilizer next to the fuselage to raise the nosewheel off the ground. When the nosewheel is held clear of the ground the airplane can be turned readily in any direction by pivoting it about the main gear. Do not push down on the empennage by the tip of the elevator nor shove sideways on the upper portion of the fin. When moving the airplane forward or backwards, push at the wing strut root fitting or at the main gear strut.

### MOORING YOUR AIRPLANE.

Proper tie-down procedure is your

best precaution against damage to your parked airplane by gusty or strong winds. To tie down your airplane securely, proceed as follows:

- (1) Tie sufficiently strong ropes or chains (700 pounds tensile strength) to the wing tie-down fittings at the upper end of each wing strut.
- (2) Secure the opposite ends of these ropes or chains to tie-down rings in the ground.
- (3) Tie a rope or chain through the nose gear tie-down ring and secure the opposite end to a tie-down ring in the ground.
- (4) Securely tie the middle of a length of rope to the ring at the tail. Pull each end of the rope away at a 45° angle and secure it to tie-down rings positioned on each side of the tail.
- (5) Install surface control locks between the flap and alleron of each wing.
- (6) Install the control lock in the control wheel shaft.

- (7) Install a surface control lock over the fin and rudder.

## STORAGE.

The all-metal construction of your Cessna makes outside storage of it practical. However, inside storage of the plane will increase its life just as inside storage does for your car. If your airplane must remain inactive for a time, cleanliness is probably the most important consideration, whether it is stored inside or outside. A small investment in cleanliness will repay you many times not only in keeping your airplane looking like new but in keeping it new. A later paragraph in this section covers the subject in greater detail.

Do not neglect the engine when storing the airplane. Turn the propeller over by hand or have it turned over every few days to keep the engine bearings, cylinder walls and internal parts lubricated. Full fuel tanks will help prevent condensation and increase fuel tank life.

Airplanes are built to be used and regular use helps to keep them in good condition. An airplane left standing idle for any great length of time is likely to deteriorate more rapidly than if it is flown regularly, and should be carefully checked over before being put back into service.

## LIFTING AND JACKING.

The airplane may be lifted by using a suitable sling at the engine mount fuselage attachment fittings and a sling around the aft section of the fuselage. The upper half of the

cowl must be removed to attach the sling at the engine mount.

Optional jacking point brackets and hoisting rings help make handling the airplane safe and easy. If no jacking point bracket is available, a block of hardwood sawed at an angle to fit between the fuselage and the main landing gear spring may be used as a jacking point to hold the airplane when working on a main wheel or tire. Do not use the brake casting as a jacking point.

To remove the nosewheel, the airplane may be held in a nose-high attitude by holding the tail down or by placing a padded support under the aft end of the nose gear support fitting. Brake or chock the main wheels when the nosewheel is being raised for removal.

## WHEEL AND TIRE REMOVAL.

Use the following procedure to remove the main and nose gear wheels and tires:

### Main Gear

- (1) Jack the strut until the tire is clear.
- (2) Remove the brake anti-rattle clips, the hub cap, cotter pins and wheel axle nut.
- (3) Pull the wheel from the axle.

### Nose Gear

- (1) Jack the nose or weight down the tail to raise the nosewheel clear of the ground. (Chock the main wheels before raising the nosewheel.
- (3) Remove the axle bolt ferrule from each side of the nose gear fork.
- (2) Remove the cotter pin, nut and

- (1) Special filler needle may be found in map compartment.
- (2) Lubricate end of filler needle by pressing against the pads in the needle case.
- (3) Place end of needle and work glycerine lubricant around guide hole in small rubber valve device located in the sidewall of the tire.

### NOTE

Opening in valve should be well lubricated before inserting needle. Needle should never be inserted dry.

- (4) Insert filler needle into valve hole with a rotating motion.

### NOTE

Do not force needle. If needle does not enter easily, relubricate.

- (5) Inflate tire as you would with a conventional valve.
- (6) Check air pressure.
- (7) Remove filler needle from valve as soon as possible.
- (8) Replace needle in case and store in map compartment.

## WHEEL AND TIRE REMOVAL (SPEED FAIRINGS INSTALLED).

If the airplane is equipped with optional speed fairings, it will be necessary to remove the main wheel fairings before removing the main wheel and tire. The nose wheel and tire may be removed with the nose

- axle bolt from the nosewheel axle.
- (4) Slide the wheel out of the nose gear fork.

### Tire Removal

- (1) Completely deflate the tire to be removed.
- (2) Remove the thru-bolts and nuts and separate the wheel halves to remove the tire.

### NOTE

A large O-ring seal is installed between the wheel halves to prevent air leakage when tubeless tires are used. During disassembly and reassembly, protect the O-ring and the wheel flanges from damage.

### Tire Installation

Before reassembling the tire and wheel, the wheel hubs may be moistened with water or neutral soap, or dusted with tire talc. Tighten the thru-bolts to the torque marked on the wheel. Inflate the tire until the beads seat, then adjust the tire pressure.

When reinstalling a main wheel, tighten the axle nut finger tight, then another half turn.

## TIRE INFLATION.

The tubeless tires on the main and nose landing gear wheels are inflated through a small rubber valve device on the tire sidewall using a special filler needle. To obtain maximum service from these tires, they should be inflated to the correct pressure using the following procedure:

wheel fairing only partially disconnected. To remove the nosewheel fairing, remove the nosewheel, deflate the nose strut, disconnect the lower torque link, and remove the upper fairing attaching bolt, which also secures the metering pin base plug inside of the strut. Then rotate the fairing 90° and slip down over fork. The instructions below describe wheel and tire removal without removing the nosewheel fairing.

#### Main Wheels and Tires:

- (1) Remove the bolt and washers from the outboard side of the speed fairing.
- (2) Remove the seven screws and washers from the inboard side of the fairing.
- (3) Lift the fairing from the wheel.
- (4) Remove the main wheel and tire in the usual manner.

#### Nose Wheel and Tire:

- (1) Remove the cotter pin, nut, and washer from either side of the speed fairing at the axle location, and pull the axle stud out of the axle.
- (2) Axle bolt ferrules secure the wheel inside the nose gear fork; these ferrules must be tapped out of each side of the fork to release the wheel axle. To do this, the nose gear fairing must be flexed outward (one side at a time) enough to permit removal of the ferrules. Remove the screws securing the nosewheel scraper to one side of the fairing if necessary for more fairing flexibility.

- (3) With the fairing flexed outward, tap out each ferrule with a suitable pin inserted through the axle from the opposite side of the wheel.
- (4) Having removed the ferrules, pull the wheel out of the speed fairing.

When changing a tire with optional speed fairings, check the clearance between the tire and the mud scraper. Proper clearance is .19 to .31 inch on the nosewheel and .25 to .38 inch on the main wheels. To adjust a scraper, loosen the scraper attaching screws on each side of the fairing, move the scraper as required and retighten the screws. Do not pry between the scraper and the fairing. The clearance check is of particular importance if a recapped tire is installed, since the growth of the tire carcass in service may have increased its diameter.

### WHEEL ALIGNMENT.

The wheel alignment has been properly set at the factory. Excessive tire wear indicates an improper wheel setting for the "on the ground" weight at which you are operating. See your Cessna dealer for realignment.

### PLASTIC WINDSHIELDS AND WINDOWS.

The windshield is a single piece, full floating, "free-blown" unit of "Longlife" plastic. To clean the plastic, wash with plenty of soap and water, using the palm of the hand to feel and dislodge any caked dirt. A soft cloth, sponge, or chamois may

off grass and bug stains and help prevent corrosion of the propeller in salt water areas.

### ALUMINUM SURFACES.

The clad aluminum used for the external parts of Cessna airplanes needs a minimum of care to keep the surface bright and polished, neat, and trim looking. The airplane may be washed with clear water to remove dirt and with gasoline, carbon tetrachloride or other non-alkaline grease solvents to remove grease, oil and paint. Household type detergent soap powders are effective cleaners, but should be used cautiously since some are strongly alkaline. Dulled aluminum surfaces may be cleaned effectively with Bon Ami. A mixture of two quarts of alcohol, two quarts of water and a package of powdered Bon Ami will be found to be particularly effective in cleaning the airplane. Waxing with a good automotive wax will help prevent corrosion, particularly in salt water areas.

### PAINTED SURFACES.

With only a minimum of care, the lacquered exterior of your Cessna will retain its brilliant gloss and rich color for many years. The lacquer should not be polished or waxed for approximately 30 days after it is applied, so that any solvent remaining in the paint may escape. After this initial curing period, regular waxing with a good automotive wax will help preserve the lacquer's luster and will afford a mea-

be used, but only as a means of carrying water to the plastic. Dry with a clean, damp chamois. Rubbing with a dry cloth builds up an electrostatic charge so that it attracts dust particles from the air. Wiping with a damp chamois will remove this charge as well as the dust.

Remove oil and grease by rubbing lightly with a cloth wet with kerosene. Do not use gasoline, alcohol, benzene, acetone, carbon tetrachloride, fire extinguisher or deicing fluids, lacquer thinner or glass window cleaning sprays as they will soften the plastic and cause crazing.

After cleaning, if no great amount of scratching is visible, wax the surface with a good grade of commercial wax. Waxing fills in minor scratches and helps to avoid further scratching. Apply the wax in a thin, even coat and bring it to a high polish by rubbing lightly with a clean, dry, soft flannel cloth.

Do not use a canvas cover to protect the windshield when the airplane is tied out, unless freezing rain or snow is expected. Canvas covers may cause crazing.

### METAL PROPELLER.

Little maintenance is required to keep your metal propeller in air-worthy condition. The blades should be thoroughly inspected at least every 25 hours for scratches, nicks and dents. When small dents and nicks appear, they should be carefully polished and shallowed out using a fine-cut file, sandpaper and crocus cloth. An occasional wiping of the metal propeller with an oily cloth will clean

sure of protection from damage.

Spilled fluids containing dyes, such as fuel and hydraulic oil if accidentally spilled on the surface should be flushed away at once to avoid a permanent stain. Battery electrolyte must be flushed off at once, and the area neutralized with an alkali such as baking soda solution, followed by a thorough rinse with clear water.

## INTERIOR CARE.

To remove dust and loose dirt from the upholstery and carpet, clean the interior regularly with a vacuum cleaner.

Blot up any spilled liquid promptly with cleansing tissue or rags. Don't pat the spot, press the blotting material firmly and hold it for several seconds. Continue blotting until no more liquid is taken up. Scrape off sticky materials with a dull knife, then spot clean the area.

Oily spots may be cleaned with household spot removers, used sparingly. Before using any solvent read the instructions on the container and test it on an obscure place in the fabric to be cleaned. Never saturate the fabric with a volatile solvent; it may damage the padding and backing materials.

Soiled upholstery and carpet may be cleaned with a foam-type detergent, used according to the manufacturer's instructions. Keep the foam as dry as possible and remove it with a vacuum cleaner, to minimize wetting the fabric.

The plastic trim, headliner, instrument panel and control knobs need only be wiped off with a damp cloth.

Never use a volatile solvent on plastic.

## LUBRICATION AND SERVICING.

Specific lubrication and servicing information is presented in figure 5-1. In addition, all pulleys, the trim tab actuator rod, control surface hinge bearings, bellcrank clevis bolts, flap handle, brake pedal pivots, rudder pedal crossbars, shimmy dampener pivots, door hinges and latches, Bowden controls, and the throttle and control rod universals should be lubricated every 1000 hours or oftener, with SAE 20 general-purpose oil.

Generally, roller chains (aileron, tab wheel and tab actuator) and control cables collect dust, sand and grit if they are greased or oiled. Except under seacoast conditions, chains and cables should be merely wiped clean occasionally with a dry cloth.

## NOSE GEAR SHOCK STRUT.

The nose gear shock strut should be kept clean, filled with fluid and correctly inflated. The exposed portion of the strut piston should be wiped with a clean dry cloth to remove dust and grit which may cut O-ring seals. Do not use a cloth moistened in hydraulic fluid.

Inflation of the nose strut should be checked whenever tire pressures are checked. The fluid level should be checked on periodic inspections, and oftener if there is evidence of leakage on the piston or around the filler valve. If the leakage is appreciable

or persistent, the strut should be serviced and repaired as necessary by your Cessna Dealer.

To check the strut inflation, jack the nose or lower the tail until the strut is fully extended and the wheel is clear of the ground. Remove the cap on the filler valve and check the pressure with a tire gage, adding or removing air as necessary to obtain 35 psi. Air may be bled out by depressing the stem of the valve core. Use the following procedure for checking the strut fluid level:

- (1) Working through the left cowl access door, remove the valve cap and depress the valve core stem to release all air pressure.
- (2) Using a 3/4-inch box end or deep socket wrench, unscrew the filler valve and remove it.
- (3) Completely compress the strut, so the stops contact the outer barrel. The fluid level should be even with the bottom of the valve hole. If it is not, add MIL-H-5606 (red) hydraulic fluid.
- (4) Completely extend the strut and replace the filler valve.
- (5) With the strut fully extended and the wheel clear of the ground, inflate the strut to 35 psi. Replace the valve cap.

## SHIMMY DAMPENER.

The shimmy dampener should be kept clean and filled with fluid. The exposed portions of the dampener shaft, particularly, should be wiped off with a clean dry cloth to remove dust and grit which may cut the seals in the dampener barrel. Do not wipe the shaft with hydraulic oil since this

tends to collect even more dust and grit.

To fill the shimmy dampener, remove it from the airplane, then pull the dampener shaft fitting end to its travel limit and fill the dampener through the opposite end while holding the unit vertical. Push the shaft upward slowly to seal off the filler hole and reinstall the shimmy dampener on the airplane. An alternate method is to submerge the dampener in fluid and work the shaft back and forth to expel air and fill the dampener with fluid.

## AIRPLANE FILE.

There are miscellaneous data, information and licenses that are a part of the airplane file. The following is a check list for that file. In addition, a periodic check should be made of the latest Civil Air Regulations to insure that all data requirements are met.

- A. To be carried in the airplane at all times:
- (1) Aircraft Airworthiness Certificate (Form ACA 1362).
  - (2) Aircraft Registration Certificate (Form ACA 500A).
  - (3) Airplane Radio Station License (if transmitter installed).
  - (4) Weight and Balance Report or latest copy of the Repair and Alteration Form (Form ACA 337).
  - (5) Airplane Equipment List.
  - (6) Airplane Log Book.
  - (7) Engine Log Book.

B. To be maintained but not necessarily carried in the airplane at

all times:

(1) A form containing the following information: Model, Registration Number, Factory Serial Number, Date of Manufacture, Engine Number, and Key Numbers (duplicate keys are available through your Cessna Dealer).

Most of the items listed are required by the United States Civil Air Regulations. Since the regulations of other nations may require other documents and data, owners of exported airplanes should check with their own aviation officials to determine their individual requirements.

### INSPECTION SERVICE AND INSPECTION PERIODS.

With your airplane you will receive an Owner's Service Policy. This policy has coupons attached to it which entitle you to a no-charge initial inspection and a no-charge 100 hour inspection. If you take delivery from your Dealer, he will perform the initial inspection before delivery of the airplane to you. If you pick up the airplane at the factory, plan to take your Cessna 172 to your Dealer reasonably soon after you take delivery on it. This will permit him to check it over and make any minor adjustments that may appear necessary. Also plan an inspection by your Dealer at 100 hours or 90 days whichever comes first. This inspection also is performed by your Dealer for you at no charge. While these important inspections will be performed for you by any Cessna Dealer, in most cases

you will prefer to have the Dealer from whom you purchase the airplane accomplish this work for you.

Civil Air Regulations require all airplanes to have a periodic (annual) inspection as required by the administrator, made by a person designated by the administrator, and in addition, 100-hour periodic inspections made by an "appropriately rated mechanic" if the airplane is flown for hire. The Cessna Aircraft Company recommends the 100-hour periodic inspection for Model 172 airplanes. The procedure for this 100-hour inspection has been carefully worked out by the factory and is followed by the Cessna Dealer organization. The complete familiarity of the Cessna Dealer organization with Cessna equipment and with Cessna procedures provides the highest type of service possible at lower cost.

Time studies of the 100-hour inspection at the factory and in the field have developed a standard flat rate charge for this inspection at any Cessna Dealer. Points which the inspection reveals require modification or repairs will be brought to your attention by the Dealer and quotations or charges will be made accordingly. The inspection charge does not include the oil required for the oil change.

Every effort is made to attract the best mechanics in each community to Cessna service facilities. Many Dealers' mechanics have attended Cessna Aircraft Company schools and have received specialized instruction in maintenance and care of Cessna airplanes. Cessna service instruction activity in the form

of service bulletins and letters is constantly being carried on so that when you have your Cessna inspected and serviced by Cessna Dealers' mechanics the work will be complete and done in accordance with the latest approved methods. Cessna Dealers maintain stocks of

genuine Cessna parts and service facilities consistent with the demand.

Your Cessna Dealer will be glad to give you current price quotations on all parts that you might need and will be glad to advise you on the practicability of parts replacement versus repairs that might be necessary.

### DEALER FOLLOW-UP SYSTEM.

Your Cessna Dealer has an owner follow-up system to notify you when he receives information that applies to your Cessna. In addition, if you wish, you may choose to receive similar notification directly from the Cessna Service Department. A subscription card is supplied to you in your airplane file for your use, should you choose to request this service. Your Cessna Dealer will be glad to supply you with details concerning these follow-up programs, and stands ready through his Service Department to supply you with fast, efficient, low cost service.

# SERVICING DIAGRAM

\*If optional quick drain valves are installed, drain fuel tank sumps daily.

RECOMMENDED FUEL:  
AVIATION GRADE---80/87  
OCTANE

RECOMMENDED ENGINE OIL:  
AVIATION GRADE  
SAE 40 BELOW 50°F  
SAE 30 BELOW 50°F  
HYDRAULIC FLUID:  
SPEC. NO. MIL-H-5606

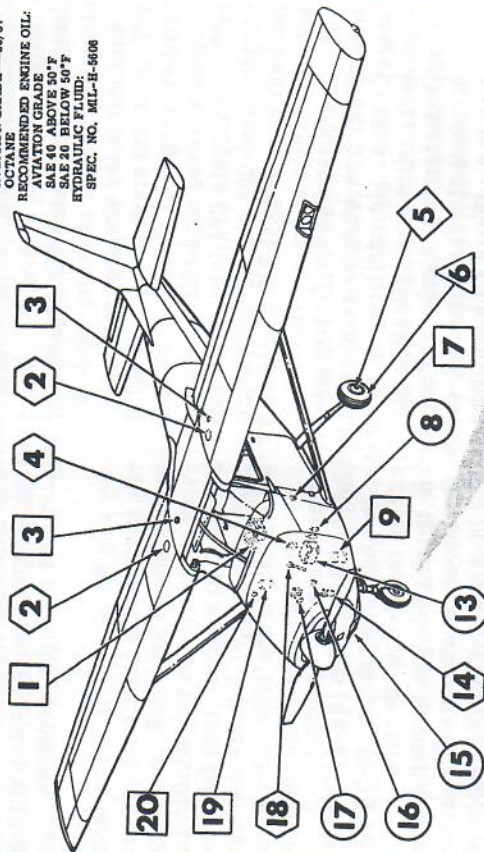

## SERVICING INTERVALS

-  CHECK OR SERVICE DAILY
-  SERVICE EVERY 25 HOURS
-  SERVICE EVERY 100 HOURS
-  SERVICE EVERY 500 HOURS
-  SERVICE OR CHECK AS REQUIRED

Symbol denotes servicing interval. Number within symbol refers to item to be serviced as shown in adjoining specifications.

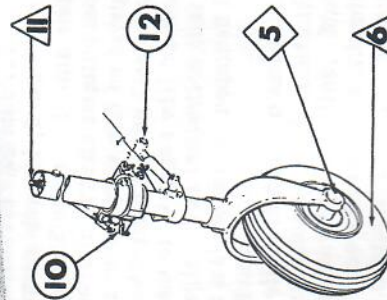

## SERVICING PROCEDURES

### 1 GYRO INSTRUMENT AIR FILTERS

Replace every 100 hours and when erratic or sluggish responses are noted with normal suction gage readings.

### 2 FUEL TANK FILLERS

Service after each flight with 80/87 octane aviation grade fuel. The capacity of each tank is 21 gallons.

### 3 FUEL TANK SUMP DRAINS

Remove drain plug, drain off water and sediment, and re-install plug. Safety wire plug to adjacent wing structure. If optional quick drain valves are installed, drain fuel tank sumps daily.

### 4 GROUND SERVICE RECEPTACLE

Connect to 12-volt, DC, negative-ground power unit for cold weather starting and lengthy ground maintenance of the electrical system. When auxiliary power unit is used, master switch should be left off until the plug has been pulled.

### 5 WHEEL BEARINGS

Repack with MIL-L-3545 wheel bearing grease at first 100 hours, 500 hours thereafter; oftener if more than the usual amount of water, mud, ice or snow is encountered.

### 6 TIRES

Maintain 35 psi pressure on the nosewheel and 23 psi on the main wheels. Inflate tires in accordance with instructions in bag which contains the filler needle (filler needle stored in map compartment). Remove oil and grease from tires with soap and water; periodically inspect them for cuts, bruises and wear.

### 7 FUEL LINE DRAIN PLUG

Remove drain plug, drain off water and sediment, and re-install plug. Safety wire plug.

### 8 BRAKE MASTER CYLINDERS

Fill with MIL-H-5606 (red) hydraulic fluid. Filling with a

Figure 5-1 (Sheet 2 of 4)

pressure pot connected to the brake bleeder ports is preferable, although fluid may be poured through the plugs on the top of the master cylinders.

#### 9 OIL FILTER (FRAM PB55)

Replace optional filter element whenever oil on dipstick appears dirty. An interval of 100 hours is considered maximum for replacement under average conditions.

#### 10 SHIMMY DAMPENER

Fill with MIL-E-5606 (red) hydraulic fluid. See page 5-7 for detailed instructions.

#### 11 NOSE GEAR SHOCK STRUT

Keep strut inflated and filled. See page 5-7 for detailed instructions.

#### 12 NOSE GEAR TORQUE LINKS

Lubricate through grease fittings with MIL-L-7711 general purpose grease. Wipe off excess.

#### 13 BATTERY

Check level of electrolyte every 25 hours (or at least every 30 days), oftener in hot weather. Maintain level of electrolyte even with the split ring at the bottom of the filler hole by adding distilled water. Neutralize any spilled electrolyte at once with baking soda solution, followed by a thorough rinse with clean water. Keep battery clean (use baking soda solution, then rinse thoroughly and dry) and battery connections tight.

#### 14 FUEL STRAINER

Drain approximately two ounces of fuel before each flight and after refueling to remove water and sediment. Make sure drain valve is closed after draining. Disassemble and clean bowl and screen each 100 hours.

#### 15 CARBURETOR AIR FILTER

Service in accordance with instructions stamped on the filter frame. Service at least every 25 hours or oftener when op-

erating in dusty conditions. Under extremely dusty conditions, daily maintenance of the filter is recommended.

#### 16 OIL SUMP DRAIN

Drain oil by removing plug in sump. Remove lower cowl and provide protection for nosewheel tire when draining.

#### 17 ENGINE OIL SCREEN

Remove and wash screen (located on right rear side of engine accessory section) with Stoddard solvent (Fed. Spec. P-S-661) whenever engine oil is changed.

#### 18 OIL FILLER AND DIPSTICK

Check oil level before each flight. Oil capacity is 8 quarts (9 quarts capacity when optional oil filter is installed). Do not operate with less than 6 quarts and completely fill the sump if an extended flight is planned. Service with aviation grade engine oil; SAE 40 above 50°F and SAE 20 below 50°F. Your Cessna was delivered from the factory with straight mineral oil and should be operated with straight mineral oil for the first 25 hours. The use of mineral oil during the 25-hour break-in period will help seat the piston rings and will result in less oil consumption. After the first 25 hours, detergent oils, conforming to Continental Motors Specification MHS-24, are recommended for use in your Cessna. Your Cessna Dealer can supply an approved brand.

#### 19 OIL SEPARATOR

Remove separator and flush with Stoddard solvent (Fed. Spec. P-S-661); then dry with compressed air and reinstall.

#### 20 SUCTION RELIEF VALVE INLET SCREEN

Check inlet screen for dirt or obstructions if suction gage readings appear high. Remove screen and clean with compressed air or wash with Stoddard solvent (Fed. Spec. P-S-661).

The military specifications listed are not mandatory, but are intended as guides in choosing satisfactory materials. Products of most reputable manufacturers meet or exceed these specifications.

Figure 5-1 (Sheet 4 of 4)

pressure pot connected to the brake bleeder ports is preferable, although fluid may be poured through the plugs on the top of the master cylinders.

#### 9 OIL FILTER (FRAM PB55)

Replace optional filter element whenever oil on dipstick appears dirty. An interval of 100 hours is considered maximum for replacement under average conditions.

#### 10 SHIMMY DAMPENER

Fill with MIL-E-5606 (red) hydraulic fluid. See page 5-7 for detailed instructions.

#### 11 NOSE GEAR SHOCK STRUT

Keep strut inflated and filled. See page 5-7 for detailed instructions.

#### 12 NOSE GEAR TORQUE LINKS

Lubricate through grease fittings with MIL-L-7711 general purpose grease. Wipe off excess.

#### 13 BATTERY

Check level of electrolyte every 25 hours (or at least every 30 days), oftener in hot weather. Maintain level of electrolyte even with the split ring at the bottom of the filler hole by adding distilled water. Neutralize any spilled electrolyte at once with baking soda solution, followed by a thorough rinse with clean water. Keep battery clean (use baking soda solution, then rinse thoroughly and dry) and battery connections tight.

#### 14 FUEL STRAINER

Drain approximately two ounces of fuel before each flight and after refueling to remove water and sediment. Make sure drain valve is closed after draining. Disassemble and clean bowl and screen each 100 hours.

#### 15 CARBURETOR AIR FILTER

Service in accordance with instructions stamped on the filter frame. Service at least every 25 hours or oftener when op-

Figure 5-1 (Sheet 3 of 4)



# INTERNAL CABIN DIMENSIONS

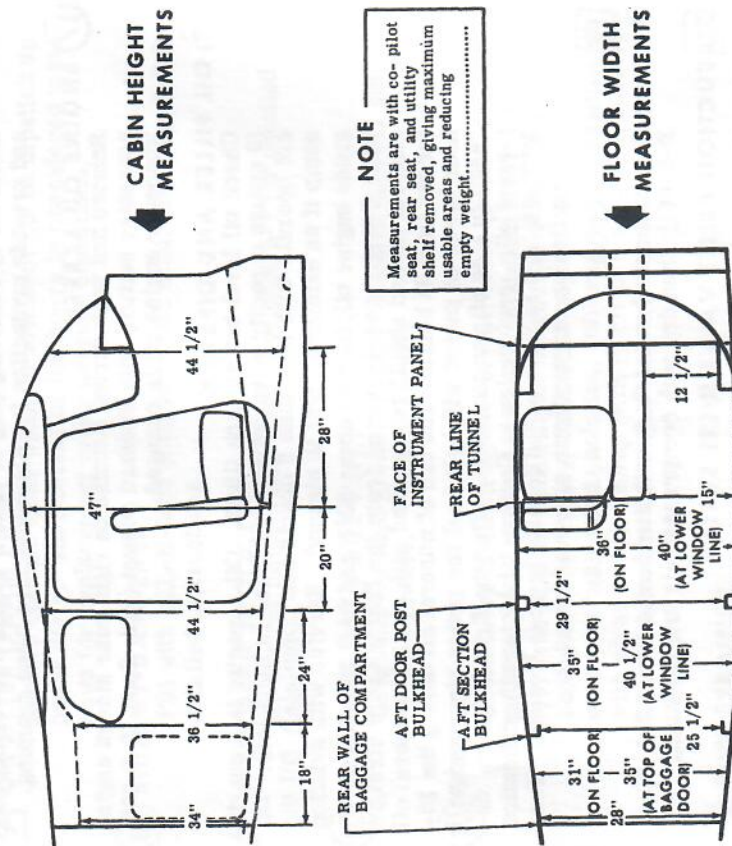

**CABIN HEIGHT MEASUREMENTS**

**FLOOR WIDTH MEASUREMENTS**

**NOTE**

Measurements are with co-pilot seat, rear seat, and utility shelf removed, giving maximum usable areas and reducing empty weight.....

**DOOR OPENING DIMENSIONS**

	WIDTH (TOP)	WIDTH (BOTTOM)	HEIGHT (FRONT)	HEIGHT (REAR)
CABIN DOOR	32"	37"	41"	38 1/2"
BAGGAGE DOOR	15 3/4"	15 3/4"	22 1/2"	21 1/4"

# Section 6

operational data



The operational data shown on the following pages are compiled from actual tests with airplane and engine in good condition and using average piloting technique and best power mixture. You will find this data a valuable aid when planning your flights. However, inasmuch as the number of variables included precludes great accuracy, an ample fuel reserve should be provided. The range performance shown makes no allowance for wind, navigational error, pilot technique, warm-up, take-off, climb, etc. All of these factors must be considered when estimating reserve fuel.

To realize the maximum usefulness from your 172, take advantage of the high cruising speeds. However, if range is of primary importance, it may pay you to fly at a low cruising rpm thereby increasing your range and allowing you to make the trip non-stop with ample fuel reserve. Use the range table on page 6-3 to solve flight planning problems of this nature.

In the table, (Figure 11), range and endurance are given for lean mixture, from 2,500 feet to 12,500 feet and for rich mixture at altitudes of 2,500 feet and 5,000 feet. All figures are based on zero wind, 39 gallons of fuel for cruise, McCauley 1C172/EM7653 propeller, 2200 pounds gross weight, and standard atmospheric conditions. For lean mixture figures, mixture is leaned to maximum RPM. Allowances for fuel reserve, headwinds, take-offs and climb, and variations in mixture leaning technique should be made and are in addition to those shown on the charts. Other indeterminate variables such as carburetor metering characteristics, engine and propeller conditions, and turbulence of the atmosphere may account for variations of 10% or more in maximum range.

## AIRSPEED CORRECTION TABLE

		FLAPS UP										FLAPS DOWN						
		40	50	60	70	80	90	100	110	120	130	140						
IAS	TIAS	59	62	66	73	81	90	99	108	118	127	136						
		40	50	60	70	80	90	100	110	120	130	140						
IAS	TIAS	49	57	65	73	82	91	100	110	120	130	140						

Figure 6-1

GROSS WEIGHT LBS.		HEAD WIND MPH		AT SEA LEVEL & 59°F		AT 2500 FT. & 50°F		AT 5000 FT. & 41°F		AT 7500 FT. & 32°F	
IAS	50 FT.	IAS	50 FT.	GROUND	TO CLEAR 50' OBSTACLE	GROUND	TO CLEAR 50' OBSTACLE	GROUND	TO CLEAR 50' OBSTACLE	GROUND	TO CLEAR 50' OBSTACLE
1600	56	0	15	380	215	470	265	555	330	680	1205
1900	61	0	15	560	335	875	415	830	515	1015	1755
2200	66	0	15	780	490	1370	605	1185	750	1435	2495
		30	30	260	165	400	210	425	610	560	1205
		30	30	380	215	590	265	555	330	680	1205
		30	30	560	335	1000	675	830	515	1015	1755
		30	30	780	490	1370	945	1185	750	1435	2495
		30	30	260	165	400	210	425	610	560	1205
		30	30	380	215	590	265	555	330	680	1205
		30	30	560	335	1000	675	830	515	1015	1755
		30	30	780	490	1370	945	1185	750	1435	2495

NOTE: INCREASE DISTANCE 10% FOR EACH 25°F. ABOVE STANDARD TEMPERATURE FOR PARTICULAR ALTITUDE.

### CLIMB DATA

NOTE: FLAPS UP, FUEL THROTTLE, AND MIXTURE LEANED FOR SMOOTH OPERATION ABOVE 5000 FT. FUEL USED INCLUDES WARM-UP AND TAKEOFF ALLOWANCE.

GROSS WEIGHT LBS.		AT SEA LEVEL & 59°F		AT 5000 FT. & 41°F		AT 10000 FT. & 23°F		AT 15000 FT. & 50°F	
BEST CLIMB RATE	CLIMB OF FUEL	BEST CLIMB RATE	CLIMB OF FUEL	BEST CLIMB RATE	CLIMB OF FUEL	BEST CLIMB RATE	CLIMB OF FUEL	BEST CLIMB RATE	CLIMB OF FUEL
1600	1.0	69	955	87	71	690	475	65	425
1900	1.0	73	710	71	475	3.3	69	65	245
2200	1.0	77	520	75	310	4.1	74	65	105
		1.0	69	87	71	690	475	65	425
		1.0	73	71	475	3.3	69	65	245
		1.0	77	75	310	4.1	74	65	105

Figure 6-2

### SKYHAWK CRUISE AND RANGE PERFORMANCE

STANDARD ATMOSPHERIC CONDITIONS  
ZERO WIND  
GROSS WEIGHT - 2200 POUNDS  
39 GALLONS OF FUEL (NO RESERVE)

RICH MIXTURE									
ALTITUDE	RPM	%BHP	TAS, MPH	GAL./ HOUR	ENDR. HOURS	MILES/ GAL.	RANGE, MILES		
2500	2700	91	136	12.6	3.1	10.7	420		
	2800	91	136	11.1	3.5	11.7	455		
	2900	91	136	10.1	3.9	12.3	480		
	2400	64	117	9.2	4.2	12.7	495		
	2300	57	111	8.5	4.6	13.1	510		
	2100	45	98	7.2	5.4	13.7	535		
5000	2700	84	135	12.1	3.2	11.2	435		
	2800	76	129	10.9	3.6	11.9	460		
	2900	71	126	10.4	3.7	12.1	470		
	2500	67	123	10.0	3.9	12.3	480		
	2400	60	116	9.1	4.3	12.7	495		
	2100	42	97	7.1	5.5	13.7	535		
LEAN MIXTURE									
2500	2700	91	137	11.3	3.4	12.0	465		
	2800	82	132	10.3	3.8	12.8	500		
	2900	72	125	9.2	4.2	13.7	535		
	2400	64	119	8.2	4.8	14.7	570		
	2300	57	113	7.2	5.4	15.6	605		
	2100	45	100	5.6	6.9	17.7	690		
5000	2700	84	137	10.7	3.6	12.8	500		
	2800	76	131	9.6	4.1	13.6	530		
	2900	71	127	9.0	4.3	14.1	550		
	2500	67	125	8.6	4.6	14.6	570		
	2400	60	118	7.6	5.1	15.5	605		
	2100	42	100	5.3	7.4	18.9	735		
7500	2650	74	132	9.4	4.1	14.1	550		
	2600	70	130	8.9	4.4	14.6	570		
	2500	63	123	7.9	4.9	15.5	605		
	2400	56	116	7.1	5.5	16.4	640		
	2300	50	110	6.4	6.1	17.3	675		
	2100	40	99	5.1	7.6	19.4	755		
10,000	2650	69	131	8.7	4.5	15.0	585		
	2600	65	128	8.3	4.7	15.4	600		
	2500	58	121	7.4	5.2	16.3	635		
	2400	52	115	6.7	5.8	17.3	675		
	2300	47	109	6.0	6.5	18.2	710		
	2100	39	99	4.9	7.9	20.2	790		
12,500	2600	61	126	7.7	5.1	16.4	640		
	2500	55	120	7.0	5.6	17.2	670		
	2400	50	114	6.3	6.2	18.2	705		
	2300	45	109	5.7	6.8	19.1	745		
	2200	41	104	5.2	7.5	20.0	780		

For standard 172 performance, subtract 1 MPH from the higher cruise speeds shown. Shaded areas are cruising RPM settings that are not recommended for the given altitude.

Figure 6-3

# LANDING DIAGRAM

**LANDING CONDITIONS**  
 APPROACH IAS 63 MPH @ 2200 LBS.  
 53 MPH @ 1600 LBS.  
 WING FLAPS - 40°  
 POWER OFF  
 HARD SURFACE RUNWAY

**NOTE**  
 Reduce Landing Distance 10%  
 for each 6MPH Headwind

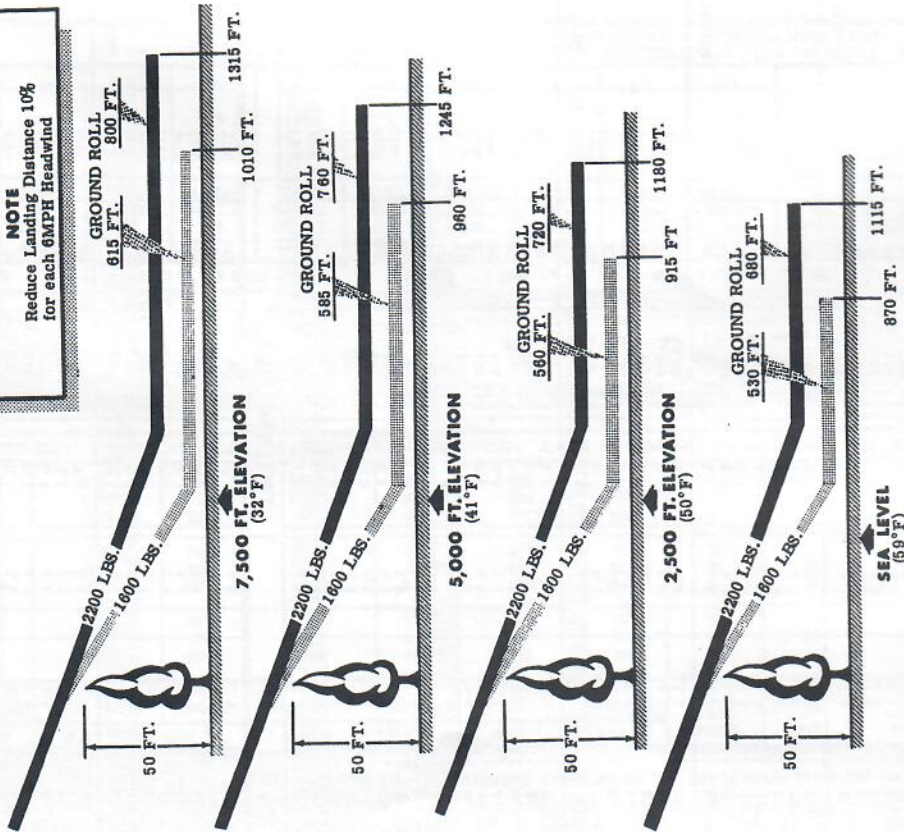

Figure 6-4

# STALLING SPEEDS

POWER OFF - MPH, TIAS  
 GROSS WEIGHT - 2200 POUNDS

CONDITION	ANGLE OF BANK		
	0°	20°	40°
FLAPS UP	58	60	66
FLAPS 10°	54	56	62
FLAPS 40°	51	53	58
			72

Figure 6-5

## Notes

# Section 7

## optional systems



This section contains a description, operating procedures, and performance data (when applicable) for the "major item" optional equipment systems in your airplane. Not all optional equipment is discussed here, rather it is those installations whose complexity and function is such that a detailed coverage is necessary for efficient utilization of the system. Optional equipment of a more simple nature, or equipment which is standard equipment on deluxe versions of the airplane, are discussed in other portions of this manual.

### LEVELAIR T-2 AND TACTAIR T-3 AUTOMATIC PILOT

Two automatic pilot systems are available as optional equipment; the systems are the Levelair T-2 by Tactair and the Tactair T-3. Many of the operating procedures are identical for both systems.

#### LEVELAIR T-2 AUTOMATIC PILOT.

The Levelair T-2 autopilot provides complete lateral stability, thereby giving the pilot additional time for navigation and visual flight operation by relieving him of most control handling duties between take-off and landing. The T-2 also provides a Course Selector and Heading Lock feature. When the system is engaged, the airplane will turn to the selected heading and hold it automatically. The system is completely pneumatic and operates by the engine-driven vacuum pump. System com-

ponents include a command control unit (see figure 7-1), a Tactair-modified directional gyro and a Tactair modified gyro horizon mounted on the instrument panel. The system also includes a signal amplifier, bellows-type servos connected to the aileron control cables, and the necessary plumbing.

Controls on the Levelair T-2 control unit are a master valve knob and a roll trim knob. The master valve knob, marked "PULL ON," is pulled out to set the system in operation. The knob, marked "ROLL TRIM," is turned to the right or left to adjust the level of the wings, as may be necessary from time to time in flight to compensate for a lighter fuel load in either of the wing tanks. There are two additional controls on the directional gyro (see figure 7-1). The gyro setting knob is used to cage

and unengage the gyro. The right hand knob on the gyro, marked "COURSE" controls the course selector card (upper compass card) and is used to select the course you wish to fly.

The Levelair T-2 is certificated for use at any altitude up to 20,000 feet. Above that altitude atmospheric pressure is insufficient to properly actuate the bellows of the servo units.

#### OPERATING CHECK LIST.

(Levelair T-2)

#### TAKE-OFF.

- (1) Master valve knob -- Check

pushed in to assure that autopilot is off.

#### CRUISE.

- (1) Trim airplane for cruising flight.
- (2) Directional gyro -- Adjust course selector knob to align course selector card with directional gyro compass card.
- (3) Roll trim knob -- Set to center.
- (4) Master valve knob -- Pull out to engage heading lock.

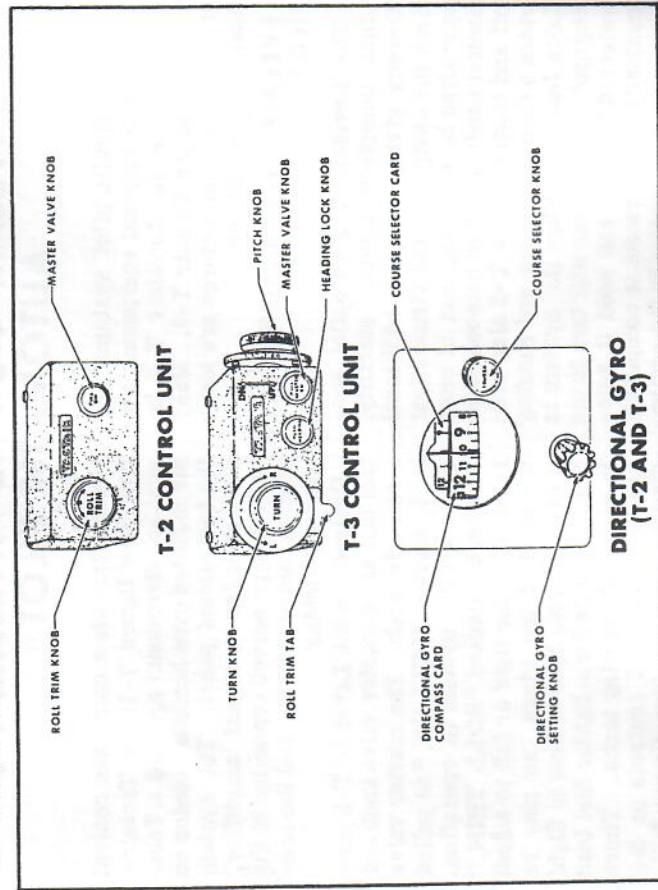

Figure 7-1. Automatic Pilot Controls

placement from the selected attitude will cause the autopilot to apply a vigorous corrective force, and a small displacement from the selected attitude will cause the autopilot to apply a mild corrective force.

The autopilot may be easily overpowered at any time. The absence of clutches or electric motors makes it possible to over-ride the autopilot indefinitely with no harm to the system.

With the airplane trimmed and the autopilot engaged, as outlined above, the Levelair T-2 is on heading lock. It will maintain the heading shown on the course selector card. If the two cards were not aligned prior to engaging the autopilot, the airplane will turn to the heading specified by the course selector card, provided that the difference in the two compass cards is less than 80 degrees. If the difference is greater than 80 degrees, the airplane will turn to the reciprocal of the heading on the course selector card. If the course selector card and the directional gyro compass card do not remain aligned, it is likely that the trim or weight distribution in the airplane is not the same as when the autopilot was initially installed and adjusted. Also, a misalignment could be due to variations in engine torque. The roll trim knob on the control unit should be adjusted until these cards remain aligned, otherwise the autopilot may have a tendency to hunt.

The heading lock can be used to turn to any new heading by turning the course selector to the new heading. However, when selecting the

- (5) Roll trim knob -- Turn for the adjustment to align compass and course selector cards, if required.

#### BEFORE LANDING.

- (1) Master valve knob -- Push in to turn off autopilot before entering traffic pattern.

#### OPERATING DETAILS.

(Levelair T-2)

It is recommended that the Levelair T-2 not be engaged prior to take-off. Forces applied to the control system by the T-2 are easily overpowered; however, these forces could significantly alter the "feel" of the airplane controls.

The Levelair T-2 requires no warm-up period before engagement since the entire system is pneumatic. Prior to engaging the autopilot, trim the airplane for straight and level flight. Center the roll trim knob and align the course selector card and directional gyro compass card. Engagement of the T-2 can then be made by pulling out on the master valve knob. It is not mandatory that this procedure be used, but it will result in the smoothest autopilot engagement. If the setting of the autopilot is different from the trim of the airplane at the time the autopilot is engaged, it will cause a brisk change of attitude. However, no excessive loads will be imposed on the airplane.

The corrective force applied by the autopilot is proportional to the disturbance; that is, a large dis-

new heading, the course selector card must not lead the directional gyro card by more than 80 degrees because the autopilot will turn to the reciprocal heading. Normal procedure is to select the new heading on the course selector and then manually bank the airplane to hasten the turn to the new heading.

The heading lock may be disengaged by caging the directional gyro. If the directional gyro compass card and the course selector card are not aligned when the directional gyro is caged, a continuous bank signal will be sent as the autopilot will attempt to realign them. Aligning the cards by either control knob will eliminate the bank signal. Once the gyro is uncaged, the heading lock will function as usual.

#### EMERGENCY PROCEDURES.

(Levelair T-2)

If a malfunction should occur in any of the autopilot units, it can be overridden merely with pressure on the normal flight controls, and the entire autopilot may be disengaged by pushing in the master valve knob. Leaks in the system will produce only a loss of suction. If the suction gage reading falls below 3.5 in. Hg, push in master valve knob to disengage autopilot. Available suction then will be directed to instruments.

#### MAINTENANCE.

(Levelair T-2)

Once the system has been adjusted

initially, it requires no further maintenance other than changing the instrument air filters on the gyros and the filters on the servo units, replacement of damaged or deteriorated tubing and inspection of the various units for security and general condition.

The instrument air filters should be replaced at least every 100 hours, or oftener if the airplane is operated under dusty conditions. Clogged filters will produce sluggish or erratic gyro responses with normal suction gage readings.

If abnormally-high suction gage readings are observed, the inlet screen on the suction relief valve should be checked and cleaned, if necessary, before attempting to re-adjust the valve. Remove the screen and clean it with solvent and compressed air; then replace it and re-check the suction gage reading.

#### TACTAIR T-3 AUTOMATIC PILOT.

The Tactair T-3 autopilot is similar to the Levelair T-2 with the addition of a means of pitch control (elevator servos) on the T-3 installation. A pitch control knob is added to the control unit (see figure 7-1). A heading lock knob, which allows the heading lock to be engaged independently is also added to the T-3 control unit, as is a turn knob, and roll trim tab. The master valve knob, directional gyro setting knob, and course selector knob are identical to, and their function and operation is the same as on the Lever T-2 autopilot.

#### OPERATING CHECK LIST.

(Tactair T-3)

##### TAKE-OFF.

- (1) Master valve knob — Check pushed in to assure that autopilot is off.

##### CRUISE.

- (1) Trim the airplane for cruising flight.
- (2) Directional gyro — Adjust the course selector knob to align course selector card with directional gyro compass card.
- (3) Pitch knob and turn knob — Set to center.
- (4) Roll trim tab — Set to center.
- (5) Heading lock knob — Push in.
- (6) Master valve knob — Pull out to engage autopilot.
- (7) Roll trim tab — Use for fine adjustment to align compass card and course selector card, if required.
- (8) Pitch knob — Adjust, if required.

#### CLIMB AND LET-DOWN.

- (1) Trim airplane for climb or let-down.
- (2) T-3 autopilot — Engage as outlined under "CRUISE" procedure above.
- (3) Pitch knob — Adjust to obtain desired pitch attitude.
- (4) If there is insufficient travel on the pitch knob to attain the desired pitch attitude, retrim the airplane.

#### BEFORE LANDING.

- (1) Master valve knob — Push in to turn off autopilot before entering traffic pattern.

#### OPERATING DETAILS.

(Tactair T-3)

The operational behavior of the Tactair T-3 heading lock feature is similar to that of the Levelair T-2. The control unit is different to accommodate the additional features of the T-3. The heading lock can be engaged or disengaged by a separate control knob marked "PUSH HEADING" which denotes the knob is pushed to engage the heading lock. With the T-3 control unit, trim alignment of the two compass cards is accomplished by use of the roll trim tab attached behind and protruding below the knob marked "TURN."

The turn knob is for command turns; that is, for turning rates higher than can be obtained with the heading lock. The turning rate is over twice as fast as that available when using the heading lock feature, as outlined in the Levelair T-2 operating information. The command turns is designed to produce a standard rate turn (3° per second) when the airplane is flying at a speed of 120 MPH. When the command turn is used, it automatically disengages the heading lock by kicking out the heading lock knob. To re-engage the heading lock, the turn knob must be returned to neutral, or center. If the course selector card has been unchanged, the airplane will return to the original

heading or, if the turn made by the command turn was greater than 80 degrees or less than 280 degrees, it will turn to the reciprocal heading. The pitch control is unique to the T-3 installation. It will maintain an attitude variation of approximately 12 degrees, nose up or nose down. Optimum results are obtained if the elevator tab is used for changes in attitude due to changes in the center of gravity or in power. Severe out-of-trim conditions may produce pitch oscillations, which will continue until aircraft is retrimmed.

### EMERGENCY PROCEDURES.

Emergency procedures for the Tactair T-3 autopilot are identical to those previously outlined for the Levelair T-2 autopilot. Maximum altitude losses during malfunction tests were 100 feet in cruise configuration and 50 feet in approach configuration.

### MAINTENANCE.

General maintenance procedures for the Tactair T-3 autopilot are identical to the T-2 autopilot.

## SEAPLANE

### DESCRIPTION.

The Cessna Model 172 seaplane is identical to the landplane with the following exceptions:

- (1) Floats, incorporating a water rudder steering system, replace the landing gear wheels, struts, and springs. A water rudder retraction handle, connected to the water rudder by cables and a spring, is located on the cabin floor tunnel. A hook for securing the handle in the "water rudder up" position is located near the elevator trim tab control wheel. Additional fuselage structure is added to support the float installation.
- (2) The standard propeller is replaced with a propeller of larger diameter and flatter pitch.
- (3) An oil radiator is installed under the engine just behind the cowling nose cap.
- (4) An additional structural "V" brace is installed between the top of the front door posts and the cowling deck.
- (5) A seaplane placard is added.

- (6) The entire airplane has additional corrosion-proofing.

### WATER RUDDER STEERING SYSTEM.

The retractable water rudder is mounted at the aft end of the right float (left float water rudder is available as optional equipment) and is connected by a system of cables and springs to the airplane rudder pedals. When the water rudder is extended, normal operation of the pedals moves the water rudder to provide steering control for taxiing.

A water rudder retraction handle, located on the cabin floor, is used to manually raise and lower the water rudder, through cables and a spring. During take-off, landing, and in flight the retraction handle is normally stowed on the water rudder retraction handle hook, located on the control tunnel near the elevator trim tab control wheel. When the handle is stowed on the hook, the water rudder is up. Removing the handle from the hook will extend the water rudder to the operating position.

## OPERATING CHECK LIST

### BEFORE ENTERING SEAPLANE.

- (1) Inspect the floats for dents, cracks, scratches, etc.
- (2) Remove the cover plates and inspect the floats for water, removing accumulation with a sponge or pump. Reinstall cover plates, tightening only enough for a snug fit.

### BEFORE STARTING ENGINE.

- (1) Operate and visually check water rudders for proper retraction.

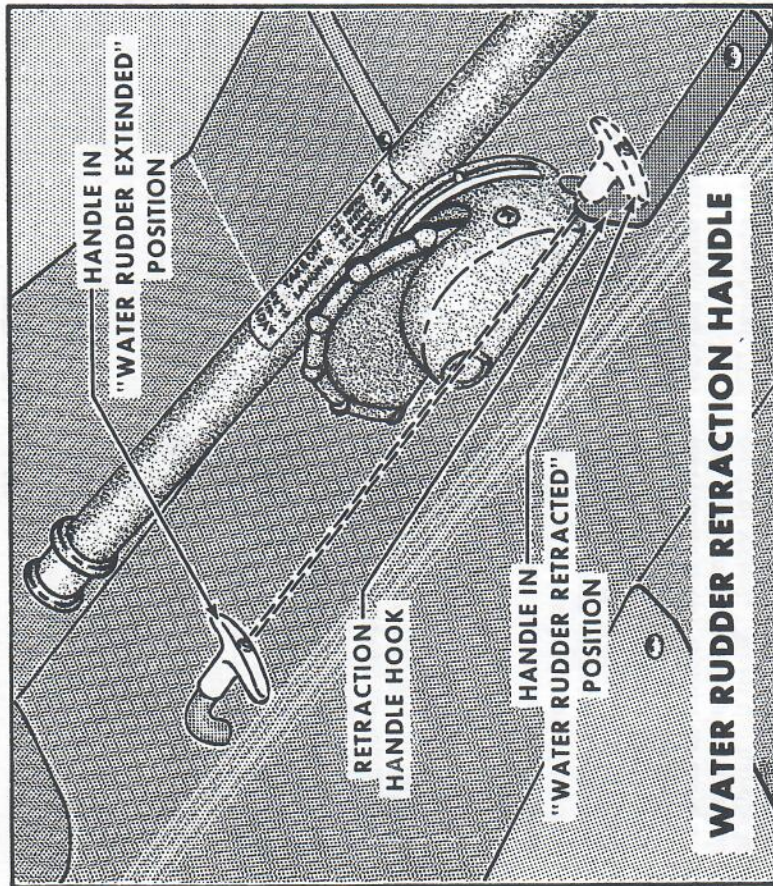

technique of raising one float out of the water may be used. This procedure is described on page 7-10 under "Minimum Run Take-off."

#### CLIMB.

The maximum rate-of-climb is obtained at full throttle and 67 MPH IAS (see the TAKE-OFF and CLIMB DATA charts on page 7-14).

#### BEFORE LANDING.

- (1) Water rudder -- Up.
- (2) Maintain 65-70 MPH with flaps extended.

#### LANDING.

- (1) Landing technique is conventional for all flap settings.

#### AFTER LANDING.

- (1) Water rudder -- Down.

### OPERATING DETAILS

#### TAXIING.

Taxi with water rudders down. It is best to limit the engine speed to 1000 RPM for normal taxi because water piles up in front of the float bow at higher engine speeds. Taxiing with higher engine RPM may result in engine overheating but will not appreciably increase the taxi speed.

For minimum taxi speed in close quarters, use idle RPM with full carburetor heat and a single magneto. This procedure is recommended for short periods of time only.

Although taxiing is very simple with the water rudders, it is sometimes necessary to "sail" the sea-plane in close quarters. In addition to the normal flight controls, the wing flaps, ailerons, cabin doors, and water rudder will aid in "sailing."

attitude (on the step) by slowly moving the control wheel forward when the bow wave moves aft of the wing strut position.

(5) As airplane accelerates, apply light control wheel back pressure and allow airplane to fly off smoothly.

(6) Climb at 60 MPH IAS to clear obstacles.

#### NOTE

To reduce take-off water run, the

tion and rudder action.

- (2) Water rudder -- Down for taxiing.

#### TAKE-OFF.

#### NORMAL TAKE-OFF.

- (1) Water rudder -- Up.
- (2) Set wing flaps 10° (first notch).
- (3) Hold the control wheel full back and advance the throttle slowly.
- (4) Place the airplane in a planing

To taxi great distances, it may be advisable to taxi on the step with the water rudder retracted. Turns on the step may be made with safety providing they are not too sharp and if ailerons are used to counteract the overturning tendency.

#### TAKE-OFF.

#### NORMAL TAKE-OFF.

The use of 10° flaps (first notch) throughout the take-off run is recommended (take-off distances are given on page 7-14). Apply full throttle smoothly and hold the control wheel full back. Watch the point where the bow wave leaves the float and move the control wheel forward slowly as this point moves aft of the wing strut. Slow control movement and light control pressures produce the best results. Attempts to force the airplane into the planing attitude will general-



ly result in loss of speed and delay in getting on the step. The airplane will assume a planing attitude which permits acceleration to take-off speed (50 to 60 MPH IAS) at which time the airplane will fly off smoothly.

**MINIMUM RUN TAKE-OFF.**

To shorten the take-off run, the following procedure is recommended: With the airplane in the planing position, allow the airspeed to build up to 40 MPH IAS, at which speed one float can be raised out of the water by slowly applying full aileron. When one float leaves the water apply slight elevator back pressure to complete the take-off. Care must be taken to stop the rising wing as soon as the float is clear of the water, and

in crosswinds, raise only the downwind wing. With one float out of the water, the airplane accelerates to take-off speed almost instantly.

If porpoising is encountered while on the step, apply additional back pressure to correct the excessively nose-low attitude.

**CROSSWIND TAKE-OFF.**

Start run with flaps up and water rudder extended for better directional control. Flaps are lowered to 10° and the water rudder retracted when the airplane is on the step and the remainder of the take-off is normal. If the floats are lifted from the water one at a time, the downwind float should be lifted first.

POWER OFF	Stalling Speeds				MPH TIAS
	ANGLE OF BANK				
Gross Weight 2220 lbs.	CONDITION				
		0°	20°	40°	60°
	FLAPS UP	59	61	67	83
FLAPS 10°	54	56	62	77	
FLAPS 40°	52	54	59	74	

**CLIMB.**

Best rate-of-climb is obtained with the seaplane at 67 MPH IAS (see chart on page 7-14) with the flaps up and full throttle. Full rich mixture is used below 5000 feet for engine cooling. For obstruction clearance with 10° flaps, climb at 55 MPH IAS. Such climbs should be of short duration due to reduced cooling at

**CRUISE.**

Observe the same engine speed limits as for the landplane. This allows 67% power for a seaplane equipped with a McCauley 1A175/SFC 8040 propeller. Speed, range and endurance are shown on page 7-15 in the CRUISE chart.

**WEIGHT AND BALANCE**

The information presented in this section will enable you to operate your 172B Seaplane within the prescribed weight and center of gravity limitations.

In figuring your loading problems be certain that you use the Licensed Empty Weight of your particular seaplane as shown on its Weight and Balance Data Sheet. This sheet plus an Equipment List is included with each seaplane as it leaves the factory. When the floats have been installed by anyone other than the factory the Repair and Alteration Form ACA-337 must be consulted for the proper weight and balance information. Refer to Section IV for procedure to be used when working loading problems.

SAMPLE LOADING PROBLEM	Sample Airplane		Your Airplane	
	Weight (lbs)	Moment (lb - ins. /1000)	Weight	Moment
1. Licensed Empty Weight (Sample Airplane) ...	1451.2	55.1		
2. Oil - 8 Qts. * .....	15.0	-0.3	15.0	-0.3
3. Pilot & Front Passenger .....	340.0	12.2		
4. Fuel - (39.0 Gal at 6#/Gal) .....	234.0	11.2		
5. Rear Passenger (1) .....	170.0	11.9		
6. Baggage .....	9.8	0.9		
7. Total Aircraft Weight (Loaded) .....	2220.0	91.0		
8. Locate this point ( 2220 at 91.0 on the center of gravity envelope, and since this point falls within the envelope the loading is acceptable.				

\*Note: Normally full oil may be assumed for all flights.

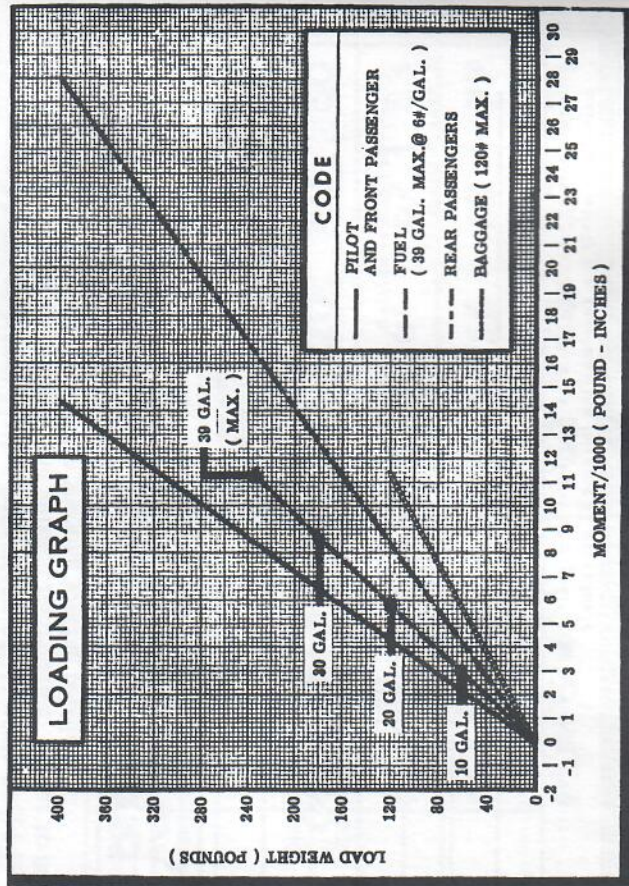
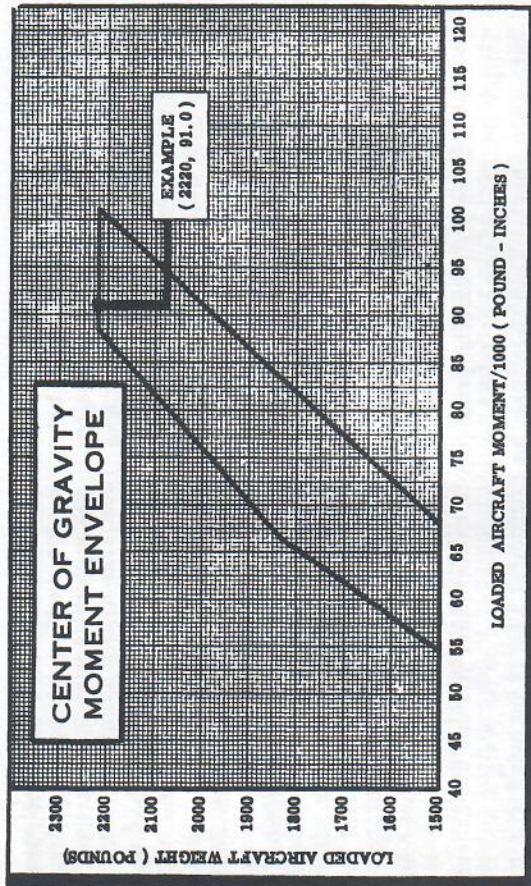

OPERATIONAL DATA.

In the Cruise Performance Chart on page 7-15, range and endurance are given for lean mixture, from 2500 feet to 12,500 feet and for rich mixture at altitudes of 2500 feet to 5000 feet. All figures are based on zero wind, 39 gallons of fuel for cruise, McCauley 1A175/SFC 8040 propeller, 2220 pounds gross weight, and standard atmospheric conditions. For lean mixture figures, mixture is leaned to maximum RPM. Allowances for fuel reserve, headwinds, take-off and climb, and variations in mixture leaning technique should be made and are in addition to those shown on the charts. Other indeterminate variables such as carburetor metering-characteristics, engine and propeller conditions, and turbulence of the atmosphere may account for variations of 10% or more in maximum range.

172 Seaplane Airspeed Correction Table 172 Seaplane

		FLAPS UP									
IAS	CAS	40	50	60	70	80	90	100	110	120	130
		61	64	67	73	80	89	98	108	117	126

		FLAPS DOWN									
IAS	CAS	50	60	70	80	90	100				
		55	64	73	82	91	100				

**SEAPLANE CRUISE PERFORMANCE**  
STANDARD ATMOSPHERE CONDITIONS  
ZERO WIND

**CRUISE PERFORMANCE WITH RICH MIXTURE**

ALTITUDE	RPM	%BHP	TAS, MPH	GAL./HOUR	ENDR. HOURS	MILES GAL.	RANGE STA. MILES
2500	2700	84	104	10.7	3.6	9.7	380
	2600	75	99	9.7	4.0	10.2	400
	2500	67	94	8.8	4.4	10.7	415
	2400	59	89	8.0	4.9	11.1	430
	2300	52	83	7.2	5.4	11.5	450
	2200	47	78	6.6	5.9	11.7	465
	2100	42	72	6.1	6.4	11.8	460
5000	2700	78	103	10.5	3.7	10.2	380
	2600	70	98	9.6	4.1	10.2	400
	2500	62	93	8.7	4.5	10.7	415
	2400	55	87	7.9	4.9	11.1	430
	2300	50	82	7.3	5.4	11.2	440
	2200	45	76	6.7	5.8	11.3	440
	2100	40	70	6.2	6.3	11.3	440

**CRUISE PERFORMANCE WITH LEAN MIXTURE**

ALTITUDE	RPM	%BHP	TAS, MPH	GAL./HOUR	ENDR. HOURS	MILES GAL.	RANGE STA. MILES
2500	2700	84	104	10.7	3.7	9.7	380
	2600	75	99	9.5	4.1	10.4	405
	2500	67	94	8.5	4.6	11.1	430
	2400	59	89	7.5	5.2	11.8	460
	2300	52	83	6.7	5.9	12.5	490
	2200	47	77	6.0	6.6	13.0	510
	2100	42	72	5.3	7.3	13.5	535
5000	2700	78	103	9.9	3.9	10.4	405
	2600	70	98	8.9	4.4	11.0	430
	2500	62	93	7.9	4.9	11.7	460
	2400	55	87	7.0	5.5	12.4	485
	2300	50	82	6.3	6.2	13.0	505
	2200	45	76	5.6	6.9	13.4	525
	2100	40	70	5.1	7.6	13.7	535
7500	2700	72	102	9.2	4.3	11.1	415
	2600	65	96	8.2	4.8	11.7	455
	2500	58	91	7.4	5.3	12.4	485
	2400	52	85	6.6	5.9	13.0	505
	2300	47	80	5.9	6.6	13.4	525
	2200	42	74	5.4	7.2	13.7	535
	2100	39	69	5.0	7.9	13.9	540
10,000	2700	67	100	8.5	4.6	11.8	460
	2600	60	95	7.7	5.1	12.3	480
	2500	54	89	6.9	5.7	12.9	505
	2400	49	83	6.2	6.3	13.4	520
	2300	45	78	5.7	6.9	13.7	535
	2200	41	73	5.2	7.5	13.7	540
	2100	38	69	4.9	8.0	14.1	550
12,500	2700	62	98	7.9	4.9	12.5	485
	2600	56	92	7.1	5.5	13.0	505
	2500	51	87	6.5	6.0	13.4	520
	2400	47	81	5.9	6.6	13.7	535
	2300	43	76	5.3	7.1	13.9	540
	2200	40	71	5.1	7.7	14.0	545
	2100	38	69	4.9	8.0	14.0	545

*Note* ..... To insure maximum engine life, cruise power settings in excess of 70% power are not recommended.

Figure 7-3

**SEAPLANE CLIMB DATA**

WARM-UP, FULL THROTTLE, MIXTURE LEANED FOR SMOOTH OPERATION ABOVE 5000 FT. FUEL USED INCLUDES

GROSS WEIGHT POUNDS	AT SEA LEVEL & 59 F.		AT 5000 FT. & 41 F.		AT 10,000 FT. & 23 F.		AT 15,000 FT. & 5 F.	
	BEST CLIMB RATE OF CLIMB	FUEL CLIMB FPM	BEST CLIMB RATE OF CLIMB	FUEL CLIMB FPM	BEST CLIMB RATE OF CLIMB	FUEL CLIMB FPM	BEST CLIMB RATE OF CLIMB	FUEL CLIMB FPM
2220	66	550	65	550	61	550	58	550
1950	62	730	61	510	59	290	53	210
1700	58	930	55	690	54	445	5.6	7.6

**SEAPLANE TAKE-OFF DATA**

TAKE - OFF DISTANCE WITH 10° FLAPS

GROSS WEIGHT POUNDS	AT SEA LEVEL & 59		AT 2500 FT. & 50 F.		AT 5000 FT. & 41 F.		AT 7500 FT. & 32 F.	
	HEAD WIND MPH	WATER TO CLEAR 50 FT. RUN	HEAD WIND MPH	WATER TO CLEAR 50 FT. RUN	HEAD WIND MPH	WATER TO CLEAR 50 FT. RUN	HEAD WIND MPH	WATER TO CLEAR 50 FT. RUN
2220	30	1620	30	1940	30	2560	30	3625
1950	15	1135	15	1405	15	1840	15	2300
1700	0	805	0	985	0	1215	0	1440

**SEAPLANE CLIMB DATA**

INCREASE DISTANCES 10% FOR EACH 25 F ABOVE STANDARD TEMPERATURE FOR PARTICULAR ALTITUDE.

GROSS WEIGHT POUNDS	AT SEA LEVEL & 59		AT 2500 FT. & 50 F.		AT 5000 FT. & 41 F.		AT 7500 FT. & 32 F.	
	HEAD WIND MPH	WATER TO CLEAR 50 FT. RUN	HEAD WIND MPH	WATER TO CLEAR 50 FT. RUN	HEAD WIND MPH	WATER TO CLEAR 50 FT. RUN	HEAD WIND MPH	WATER TO CLEAR 50 FT. RUN
2220	30	1620	30	1940	30	2560	30	3625
1950	15	1135	15	1405	15	1840	15	2300
1700	0	805	0	985	0	1215	0	1440

Figure 7-2

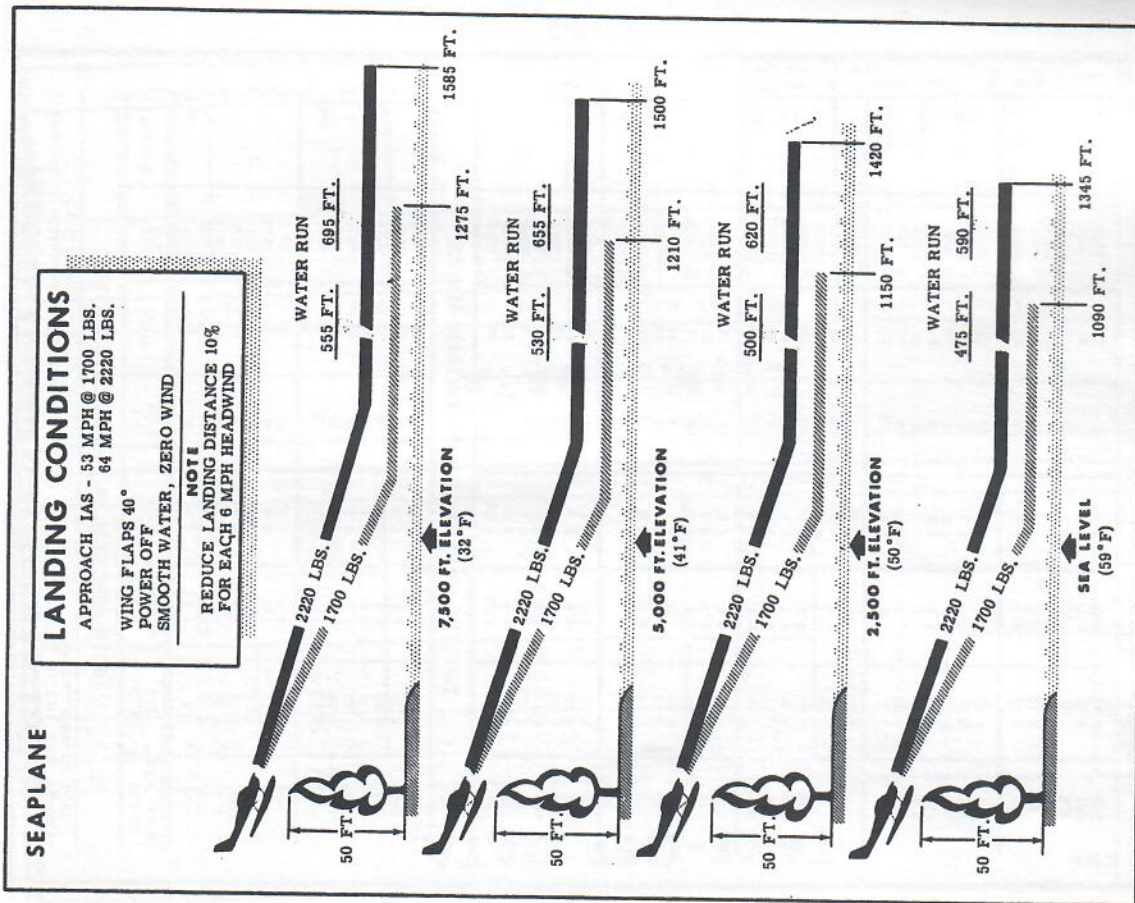

Figure 7-4

## AUXILIARY FUEL TANK SYSTEM

An optional auxiliary fuel tank system (figure 7-5) is available to increase the airplane operating range. System components include an 18 gallon fuel tank (17.55 gallons usable) installed on the baggage compartment floor, an electric fuel pump installed behind the tank, an electrically-operated fuel quantity indicator and fuel pump switch on the instrument panel, a fuel tank filler provision on the right side of the fuselage, a fuel tank sump drain valve at the front of the tank on the bottom of the fuselage, and the necessary plumbing.

The auxiliary fuel system is connected to the right main fuel tank plumbing above the right cabin door.

### AUXILIARY FUEL SYSTEM OPERATION.

To operate the auxiliary fuel system, proceed as follows:

- Prior to flight:
- (1) Turn on master switch and check fuel quantity indicator for reading.
  - (2) Momentarily pull on auxiliary fuel pump switch and listen for pump operation. Turn off master switch.
  - (3) Check quantity of fuel in tank for agreement with fuel quantity indicator. Fill tank for anticipated requirements.
  - (4) Drain small amount of fuel from fuel tank drain valve to check for possible water and sediment.
- During flight:
- (1) Take-off, climb, and land with

fuel selector valve handle set in "BOTH ON" position for maximum safety.

- (2) After leveling off at cruise altitude switch to "RIGHT TANK" position and operate from this tank until the fuel supply is exhausted.
- (3) Switch to "LEFT TANK" position for operation, then pull on auxiliary fuel pump switch and refill right main fuel tank from auxiliary tank. Push auxiliary fuel pump switch to "Off" position when fuel transfer is completed.

### NOTE

Transfer of fuel will take from 45 minutes to 1 hour.

- (4) Return fuel selector valve handle to "BOTH ON" position after refilling right tank, or if desired, switch again to right main tank.

### IMPORTANT

Do not operate the auxiliary fuel tank pump with the fuel selector turned to either "BOTH" or "RIGHT TANK" positions after fuel transfer has been completed, as total or partial engine stoppage will result from air being pumped into fuel lines. If the pump should accidentally be turned on with the selector in either of these positions, and engine stoppage occurs, the engine will restart in from 3 to 5 seconds after turning off the auxiliary pump as the air in the fuel line will be evacuated rapidly.

ALPHABETICAL INDEX

**A**

After Landing, 2-3  
 Air Induction System, 1-4  
 Airplane File, 5-7  
 Airplane Tie-down Procedure, 5-1  
 Airspeed Correction Table, 6-1  
 seaplane, 7-13  
 Airspeed Indicator, iv  
 Airspeed Limitations, 4-2  
 Alignment - Wheel, 5-4  
 Altimeter, iv  
 Aluminum Surfaces, 5-5  
 Automatic Pilot, 7-1  
 controls, 7-2  
 Levelair T-2, 7-1  
 Tactair T-3, 7-4  
 Auxiliary Fuel System, 7-17  
 operation, 7-17  
 schematic, 7-18

**B**

Baggage Compartment, 1-22  
 Beacon - Rotating, 1-17  
 Before Entering Airplane, 2-1  
 seaplane, 7-7  
 Before Landing, 2-3  
 seaplane, 7-9  
 Before Starting Engine, 2-1  
 seaplane, 7-7  
 Before Take-off, 2-2, 3-4  
 Brake Operation - Parking, 1-15  
 Brake System, 1-14  
 Button - Starter, iv, 1-4

**C**

Cabin Air Knob, 1-10  
 Cabin Doors, 1-21  
 Cabin Heat Knob, 1-10  
 Cabin Heating and Ventilating System, 1-18, 1-19  
 Cabin Ventilators, 1-20  
 Cabin Windows, 1-22  
 Carburetor Air Heat Knob, 1-1, 1-3  
 Carburetor Air Temperature Gage, 1-16  
 Care - Interior, 5-6  
 Care of the Airplane, 5-1  
 Cargo Tie-down Rings, 1-23  
 Center of Gravity Envelope, 4-4  
 seaplane, 7-12

**D**

Data - Climb, 6-2  
 seaplane, 7-14  
 Data - Fuel Quantity, 1-8  
 Data - Landing, 6-4  
 seaplane, 7-16  
 Data - Take-off, 6-2  
 seaplane, 7-14  
 Dealer Follow-up System, 5-9  
 Diagram - Exterior Inspection, 1-24  
 Diagram - Landing, 6-4  
 Diagram - Servicing, 5-10  
 Diagram - Taxiing, 3-3  
 Dimensions, ii  
 Dome Lights, 1-18  
 Doors - Cabin, 1-21  
 lock, 1-21  
 Drain Knob - Fuel Strainer, 1-8  
 Drain Plug - Fuel Line, 1-8  
 Drain Plugs - Fuel Tank Sump, 1-8

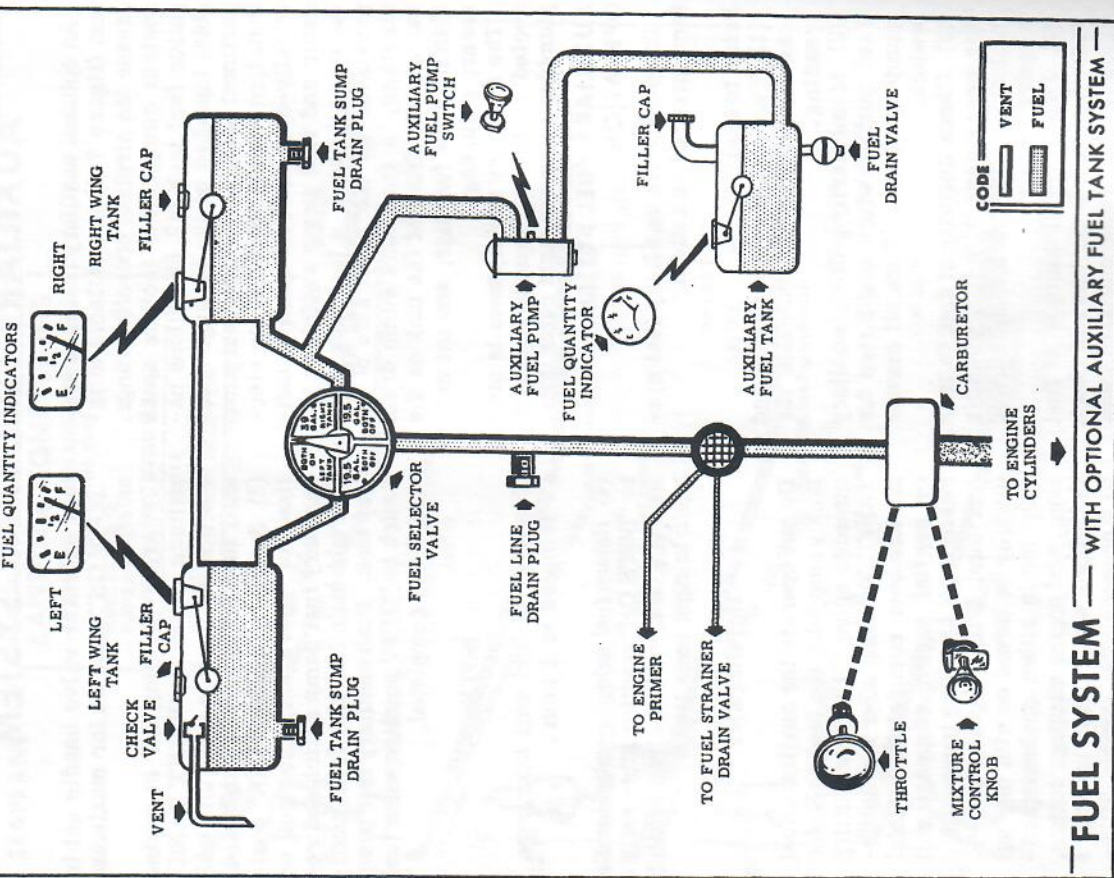

Figure 7-5

- Drain Valves - Fuel Tank Sump, 1-9
- Electrical System, 1-9  
power distribution diagram, 1-11
- Elevator Tab Control Wheel, 1-12, 1-13
- Engine, 1-1  
before starting, 2-1  
controls, 1-1  
instrument markings, 4-2  
operation limitations, 4-2  
primer, 1-2  
primer knob, 1-3  
starting, 2-1, 3-1
- Envelope - Weight and Balance, 4-4
- Exterior Inspection Diagram, 1-24
- Extinguisher - Fire, 1-22
- F
- Fuel - Airplane, 5-7
- Filter - Oil, 1-4
- Fire Extinguisher, 1-22
- Flap Handle, 1-12, 1-13
- Flight Control System, 1-12
- Flight Instruments, iv
- Front Seats, 1-21  
reclining, 1-21
- Fuel Line Drain Plug, 1-8
- Fuel Quantity Data, 1-8
- Fuel Quantity Indicators, 1-9, 4-3
- Fuel Selector Valve, 1-6
- Fuel Strainer Drain Knob, 1-3, 1-8
- Fuel Specification and Grade, 5-10
- Fuel System, 1-6  
schematic, 1-7
- Fuel System - Auxiliary, 7-17  
schematic, 7-18  
operation, 7-17
- Fuel Tank Sump Drain Plugs, 1-8
- Fuel Tank Sump Drain Valves, 1-9
- Fuses, 1-3, 1-9
- G
- Gage - Carburetor Air Temperature, 1-16
- Gage - Cylinder Head Temperature, 1-17, 4-3
- Gage - Oil Pressure, 1-4, 4-3
- Gage - Oil Temperature, 1-4, 4-2
- Gear - Landing, 1-13
- Generator Warning Light, 1-10
- Ground Handling, 5-1
- Ground Service Receptacle, 1-10
- Gyro Instruments, 1-14
- H
- Handle - Starter, iv, 1-3
- Handle - Wing Flap, 1-12, 1-13
- Headphone Jack, iv
- Heater - Pitot and Stall Warning, 1-16
- Heating and Ventilating System, 1-18, 1-19
- Hook - Coat Hanger, 1-22
- I
- Ignition Switch, 1-2, 1-3
- Indicator - Airspeed, iv
- Indicator - Stall Warning, 1-16
- Indicator - Turn and Bank, 1-14
- Indicators - Fuel Quantity, 1-9, 4-3
- Indicators - Oil System, 1-4
- Indicators - Pitot-Static System, 1-16
- Inflation - Tire, 5-3
- Inspection Diagram - Exterior, 1-24
- Inspection Service and Inspection Periods, 5-8
- Instrument Lights, 1-18  
rheostat, iv
- Instrument Markings, 4-2
- Instrument Panel, iv
- Instruments, 1-14
- Instruments - Flight, iv
- Instruments - Vacuum-operated, 1-14
- Interior Care, 5-6
- J
- Jack - Headphone, iv
- Jacking and Lifting, 5-2
- K
- Kit - Winterization, 1-23
- Knob, cabin air, 1-10  
cabin heat, 1-10  
carburetor air heat, 1-1, 1-3  
engine primer, 1-3  
fuel strainer drain, 1-3, 1-8  
mixture control, 1-1, 1-3  
parking brake, 1-10
- L
- Landing, 3-6  
after, 2-3  
before, 2-3  
data - seaplane, 7-16  
diagram, 6-4  
normal, 2-3  
Normal Landing, 2-3  
Normal Take-off, 2-2  
Nose Gear, 1-14  
shock strut, 5-6
- Landing Light, 1-17  
switch, 1-10
- Let-down, 2-3
- Levelair T-2 Automatic Pilot, 7-1
- Lifting and Jacking, 5-2
- Light - Dome, 1-18
- Light - Generator Warning, 1-10
- Light - Landing, 1-17
- Light - Map, 1-18
- Lighter, 1-3
- Lights - Navigation, 1-17
- Lights - Instrument, 1-18
- Lights - Instrument, 1-18
- Lights - Navigation, 1-17
- Limitations - Airspeed, 4-2
- Limitations - Engine Operating, 4-2
- Limitations - Operating, 4-1
- List - Operating Check, 2-1
- Loading Your Model 172, 1-23  
graph, 4-4  
sample problem, 4-5
- seaplane, 7-11, 7-12
- Lock - Door, 1-21
- Lock - Controls, 1-12
- Lubrication and Servicing, 5-6
- M
- Magnetic Compass, iv
- Main Landing Gear, 1-13
- Maneuvers - Normal Category, 4-1
- Maneuvers - Utility Category, 4-1
- Map Compartment, iv
- Map Light, 1-18
- Map Pocket, 1-12, 1-22
- Master Switch, 1-9, 1-10
- Maximum Performance Climb, 2-2
- Maximum Performance Take-off, 2-2
- Microphone, 1-12
- Miscellaneous Equipment, 1-21
- Mixture Control Knob, 1-1, 1-3
- Mooring Your Airplane, 5-1
- N
- Navigation Lights, 1-17  
switch, 1-10
- Normal Category Maneuvers, 4-1
- Normal Climb, 2-2
- Normal Landing, 2-3
- Normal Take-off, 2-2
- Nose Gear, 1-14  
shock strut, 5-6
- O
- Oil Filter, 1-4
- Oil Level, 1-4
- Oil Pressure Gage, 1-4, 4-3
- Oil Specification and Grade, 5-10
- Oil System, 1-4  
indicators, 1-4  
schematic, 1-5  
temperature gage, 1-4, 4-2  
pressure gage, 1-4, 4-3
- Operating Check List, 2-1  
seaplane, 7-7
- Operating Details, 3-1
- seaplane, 7-9
- Operating Limitations, 4-1  
engine, 4-2
- Operation - Cold Weather, 3-7  
7-17
- Operation - Auxiliary Fuel System, 7-17
- Operation - Parking Brake, 1-15
- Operational Data, 6-1
- Operations Authorized, 4-1
- Optional Systems, 7-1
- P
- Painted Surfaces, 5-5
- Panels - Switch and Control, iv, 1-3, 1-10
- Parking Brake Knob, 1-10
- Parking Brake Operation, 1-15
- Pedals - Rudder, 1-12
- Pitot and Stall Warning Heat, 1-16
- Pitot-Static System Indicators, 1-16
- Pocket - Map, 1-12, 1-22
- Pre-Flight Check, 3-1
- Pressure Gage - Oil, 4-3
- Primer - Engine, 1-2  
knob, 1-3
- Principal Dimensions, ii
- Propeller, 5-5

## R

Range and Cruise Performance, 6-3  
seaplane, 7-15  
Rear Seat, 1-21  
Rear Seat Ventilators, 1-20  
Reclining Front Seats, 1-21  
Rheostat - Instrument Lights, iv  
Rings - Cargo Tie-down, 1-23  
Rotating Beacon, 1-17  
Rudder Pedals, 1-12

## S

Sample Loading Problem, 4-5  
seaplane, 7-11  
Schematics,  
auxiliary fuel system, 7-18  
fuel system, 1-7  
oil system, 1-5  
Seaplane, 7-7  
airspeed correction table, 7-13  
cruise performance, 7-15  
landing data, 7-16  
operating check list, 7-7  
operating details, 7-9  
stalling speeds, 7-10  
take-off and climb data, 7-14  
weight and balance, 7-11  
Seats, 1-21

Selector Valve - Fuel, 1-6  
Servicing Diagram, 5-10  
Servicing and Lubrication, 5-6  
Shelf - Utility, 1-22  
Shimmy Dampener, 5-7  
Shock Strut - Nose Gear, 5-6  
Speed Fairings, 1-14  
Stall Warning Indicator, 1-16  
Stalling Speeds, 6-5  
seaplane, 7-10  
Stalls, 3-6  
Starter Button, iv, 1-4  
Starter Handle, iv, 1-3  
Starting Engine, 2-1, 3-1  
Storage, 5-2  
Strainer Drain Knob - Fuel, 1-8  
Strut - Nose Gear Shock, 5-6  
Sump Drain Plugs - Fuel Tank, 1-8  
Sump Drain Valves - Fuel Tank,  
1-9

Switches, iv, 1-3, 1-10  
ignition, 1-2, 1-3  
landing light, 1-10  
master, 1-9, 1-10  
navigation, 1-10

## Index-4

## T

Table of Contents, iii  
Tachometer, iv, 4-3  
Tactair T-3 Automatic Pilot, 7-4  
Take-off, 2-2, 3-4  
before, 2-2, 3-4  
data, 6-2  
maximum performance, 2-2  
normal, 2-2  
seaplane, 7-14  
Taxiting, 3-3

diagram, 3-2  
seaplane, 7-9

Temperature Gage - Carburetor

Air, 1-16  
Temperature Gage - Cylinder Head,  
1-17, 4-3  
Temperature Gage - Oil, 4-2  
Throttle, 1-1, 1-3  
Tie-down Procedure, 5-1  
Tie-down Rings - Cargo, 1-23  
Tire and Wheel Removal, 5-2, 5-3  
Tire Inflation, 5-3  
Turn and Bank Indicator, 1-14

## U

Utility Category Maneuvers, 4-1  
Utility Shelf, 1-22

## V

Vacuum-operated Instruments, 1-14  
Valve - Fuel Selector, 1-6  
Ventilators - Cabin, 1-20  
rear seat, 1-20

## W

Warning Light - Generator, 1-10  
Weight and Balance, 4-3  
envelope, 4-4  
seaplane, 7-11  
seaplane envelope, 7-12  
Wheel Alignment, 5-4  
Wheel and Tire Removal, 5-2, 5-3  
Wheel - Elevator Tab Control, 1-12,  
1-13  
Windows - Cabin, 1-22, 5-4  
Windsield, 5-4  
Wing Flap Handle, 1-12, 1-13  
Winterization Kit, 1-23

## WARRANTY



■ The Cessna Aircraft Company warrants each new airplane, manufactured by it, to be free from defects in material and workmanship under normal use and service, provided, however, that this warranty is limited to making good at the Cessna Aircraft Company's factory any part or parts thereof which shall, within ninety (90) days after delivery of such airplane to the original purchaser, be returned to the Company with transportation charges prepaid, and which upon Company examination shall disclose to the Company satisfaction to have been thus defective; this warranty being expressly in lieu of all other warranties expressed or implied and all other obligations or liabilities on the part of the Company, and the Company neither assumes nor authorizes any other person to assume for it any other liability in connection with the sale of its airplanes.

■ This warranty shall not apply to any airplane which shall have been repaired or altered outside the Company's factory in any way so as, in its judgment, to affect its stability or reliability, nor which has been subject to misuse, negligence or accident.

CESSNA AIRCRAFT COMPANY  
WICHITA, KANSAS



"LOOK FOR THE RED AND BLUE  
CESSNA PENNANTS FOR THAT  
EXTRA SERVICE WHERE IT COUNTS  
WHEN YOU NEED IT."